

D9050PCIC PCIe 5.0 TX Compliance Test Software

PCI Express 5.0 (Gen5) Electrical Performance Validation and Compliance Software for UXR and Z-Series Real-Time Oscilloscopes.

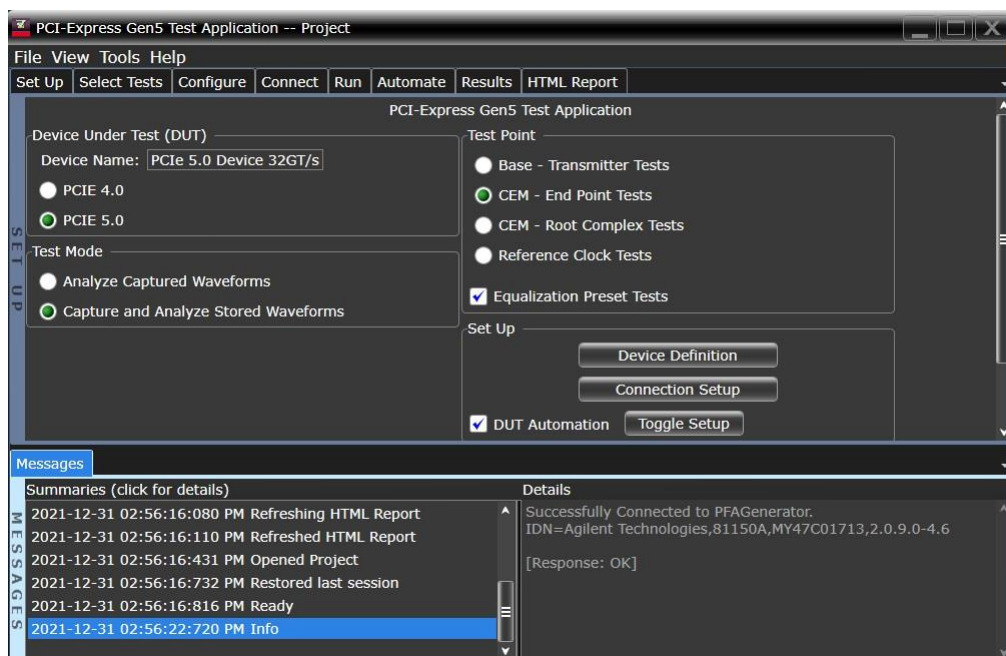

Key features

The Keysight D9050PCICPCI Express 5.0 electrical transmitter (TX) test software represents the latest PCI Express TX test tool that supports testing of PCI Express 5.0 devices with speeds of up to 32 GT/s.

Key Features¹

The Keysight D9050PCIC PCI Express 5.0 electrical transmitter (TX) test software represents the latest PCI Express TX test tool that supports testing of PCI Express 5.0 devices with speeds of up to 32 GT/s. Below is a list of a few of the key features of this software package.

- Supports Transmitter Testing under the PCIe 5.0 BASE Specification at 32, 16, 8, 5, and 2.5 GT/s
- PCIe® 5.0 BASE TX measurements³ including uncorrelated TJ, DJ, and PWJ, pseudo package loss and other parameters defined in the PCI Express BASE specification
- PCIe® 5.0 CEM 5.0 TX Measurements for end point (add-in cards) and root port (motherboard) devices at 32, 16, 8, 5, and 2.5GT/s
- PCI 5.0 reference clock measurements as defined in the PCIe 5.0 BASE spec
- DUT automation for automatic selection of TX test patterns for CEM 5.0 testing using a Keysight 81150A or 81160A Pulse Function Arbitrary Noise Generator
- Workshop Compliance Mode for rapid, PCI-SIG-style pre-compliance testing
- Support for de-embedding² of test fixtures, high speed switches and cable. Also supports selection of CEM 5.0 S4P loss functions for add-in card and motherboard testing at 32GT/s
- Two-port (explicit clock and data) supported³ for CEM 5.0 Root Port (motherboard) signal quality testing at 5G, 8G, and 16G
- Supports both real-time data capture as well as off-line analysis of previously captured waveforms
- Test setup wizard for ease-of-use
- Pass/fail margin analysis
- Support for both full-swing and low-power, half-swing devices
- Supported on Keysight Z-Series and UXR Series real time oscilloscopes having a minimum bandwidth of 50 GHz (33GHz minimum bandwidth required for CEM-only transmitter testing)

Description

The D9050PCIC PCI Express electrical performance validation and compliance software for PCI Express 5.0 provides you with a fast and easy way to verify and debug your PCI Express 5.0 design for both silicon validation (as per the PCIe® 5.0 BASE specification) as well as for PCI Express 5.0 add-in cards and motherboard systems (as per the PCIe 5.0 CEM specification).

The PCI Express electrical test software allows you to automatically execute PCI Express electrical transmitter tests, and it displays the results in a flexible report format. In addition to the measurement data, the report provides a margin analysis that shows how closely your device passed or failed each test.

The D9050PCIC PCI Express electrical performance validation and compliance software performs a wide range of electrical tests as per the PCI Express PCI Express 5.0 specification only and supports testing transmitters that operate at 32, 16, 8, 5, and 2.5 GT/s. In addition to full swing (800 mV) testing, the software also supports testing for low-power, half-swing devices (400 mV).

1. Features subject to change without notice.

2. Requires the purchase of the optional Keysight InfiniiSim Waveform Transformation Toolset for Infiniium oscilloscopes.

3. Requires capturing two differential signals (such as with a 4-channel oscilloscope)

PCI Express Compliance Testing

To pass signal quality testing at a PCI-SIG-sponsored compliance workshop, your product must successfully pass “Gold Suite” testing, based on the PCI-SIG SigTest application. The SigTest application tests your device against the minimum signal-quality performance requirements for PCI. If you are developing receivers and transmitters for add-in boards and system motherboards, the D9050PCIC PCI Express electrical test software helps you execute the SigTest tests and additional oscilloscope already completed tests.

While SigTest tests provide a good overview of PCI Express electrical signal quality, they address only a small subset of the electrical compliance measurements specified in the PCI-SIG specification. The SigTest application also provides minimal reporting capability with pass/fail indication and measurement values and has limited debugging capabilities to decipher eye mask violations or excessive jitter.

For PCI Express 5.0 measurements, the software automatically calculates uncorrelated total jitter, uncorrelated deterministic jitter, uncorrelated PWJ necessary for validating new PCIe 5.0 compliant chipsets.

Benefits

PCI Express electrical test software benefits

The D9050PCIC PCI Express electrical test software saves you time by setting the stage for automatic execution of PCI Express electrical tests. Part of the difficulty of performing electrical tests for PCI Express is hooking up the oscilloscope, loading the proper setup files, and then analyzing the measured results by comparing them to limits published in the specification. The PCI Express electrical test software does much of this work for you. In addition, if you discover a problem with your device, robust debug tools are available to aid in root-cause analysis.

The D9050PCIC software also has an integrated interface for controlling the InfiniiSim Waveform Transformation Toolset for de-embedding of test fixtures and for easily adding the appropriate loss functions needed to complete CEM 5.0 testing at 32GT/s. Introduced with PCIe 2.0, de-embedding of test fixtures utilizes S-parameters as input to create a de-embed model that helps to restore high frequency signal content that is often lost or significantly attenuated by test fixtures and cables. This can help to recover significant jitter margin normally lost to fixtures used in a test setup. This helps ensure consistent run-to-run setup of the instrumentation, saving you time and providing consistent and accurate receive test results. As an alternative to de-embedding using s-parameter files, the D9050PCIC also supports the use of selecting a PCIe 5.0 CTLE equalization level to help compensate for break-out board losses.

Easy Test Definition

The D9050PCIC PCI Express electrical test software extends the ease-of-use advantages of Keysight's Infiniium oscilloscopes to testing PCI Express designs. The Keysight automated test engine walks you quickly through the steps required to define the tests, set up the tests, perform the tests, and view the test results. You can select a category of tests all at once or specify individual tests. You can save tests and configurations as project files and recall them later for quick testing and review of previous test results. Straightforward menus let you perform tests with a minimum of mouse clicks.

Select the characteristics of your device, including whether you are testing with SSC enabled

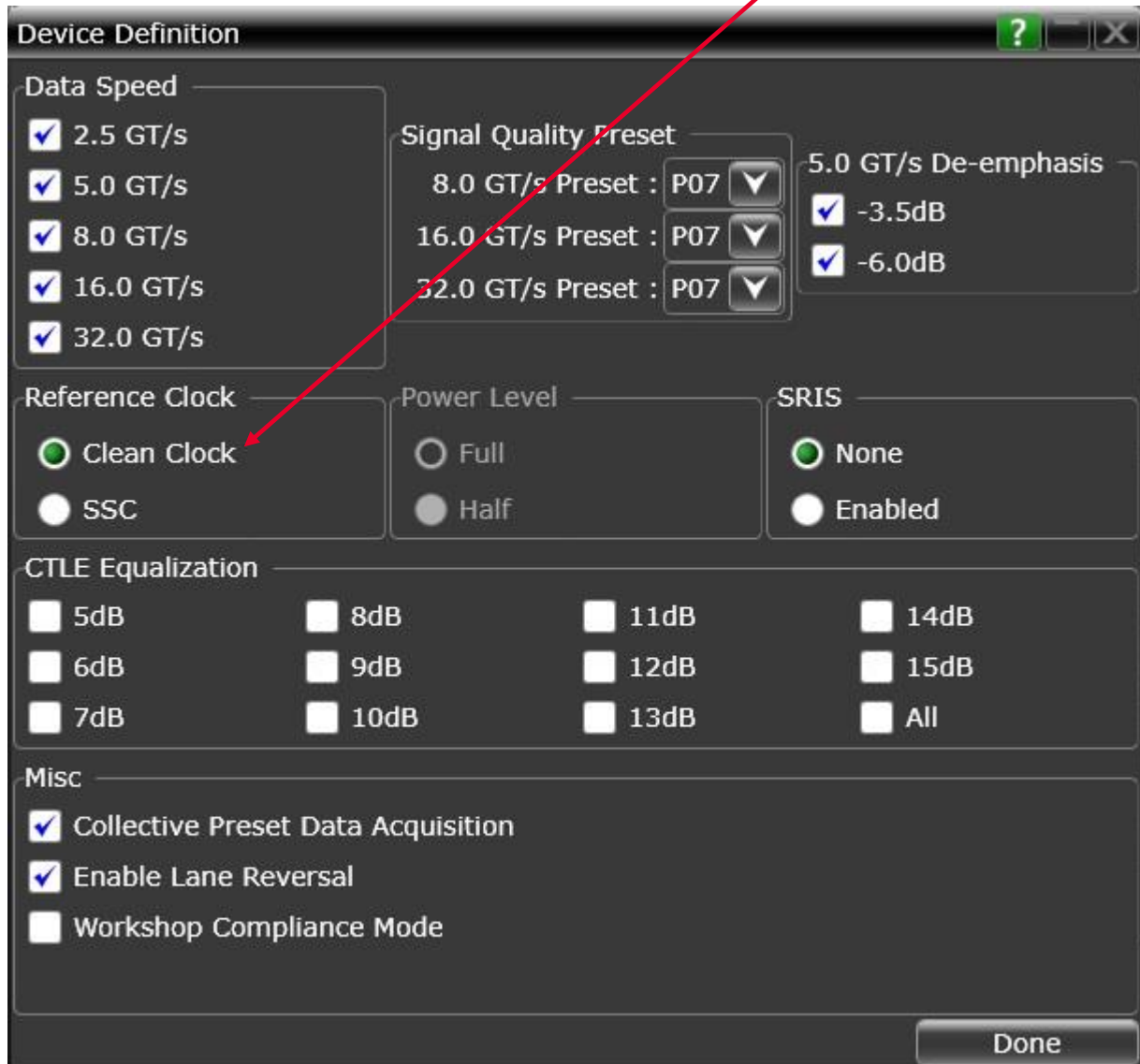

Figure 1. The Keysight automated test engine guides you quickly through configuring the tool for your device, selecting tests, configuring tests, setting up the connection, running the tests and viewing the results.

PCI Express 5.0

The D9050PCIC compliance application includes support for testing PCI Express 5.0 devices including new silicon, add-in cards, motherboards, switches. This specification elevates the data rate for PCIe 5.0 devices to 32 GT/s. This results in a maximum throughput of approximately 4 GB/s per lane and up to ~128 GB/s bidirectionally. PCIe 5.0 shares many elements in common with PCIe 4.0 including 128/130 bit encoding. Nevertheless, at 32 GT/s, the signal is significantly attenuated after even a short length of channel. Many designers may choose to go with lower loss materials when designing with PCIe 5.0 technology which increases the importance of making sure your design has the best signal integrity possible. With Keysight oscilloscopes, you can rest assured that you are using instruments with the lowest noise floor in the industry which helps you to perform your compliance tests with the greatest margin possible.

Specify the InfiniiSim de-embed transfer function to compensate for breakout channel

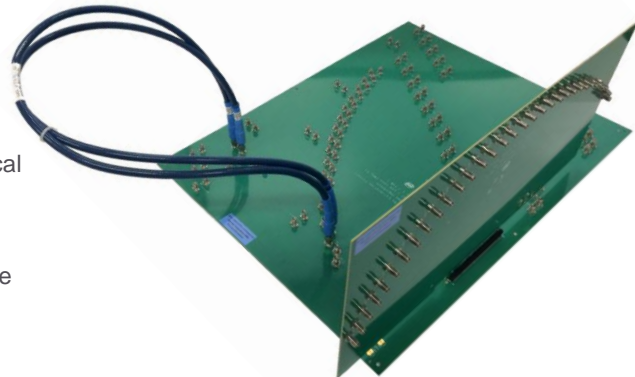
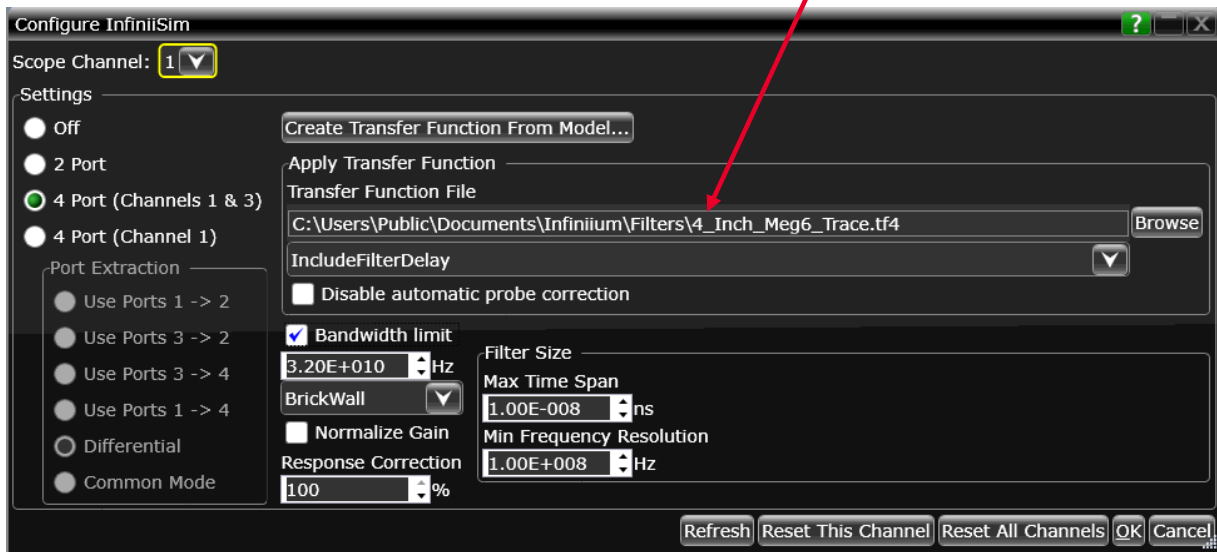

Figure 2. The D9050PCIC PCI Express 5.0 electrical performance validation and compliance software provides you with integrated access to Keysight's Infiniisim waveform transformation toolset (separate license required) for de-embedding of ASIC test channels.

PCI Express CEM 5.0 Testing

The D9050PCIC supports the testing of CEM 5.0 devices at speeds up to 32GT/s using the PCI-SIG CEM test fixture set.

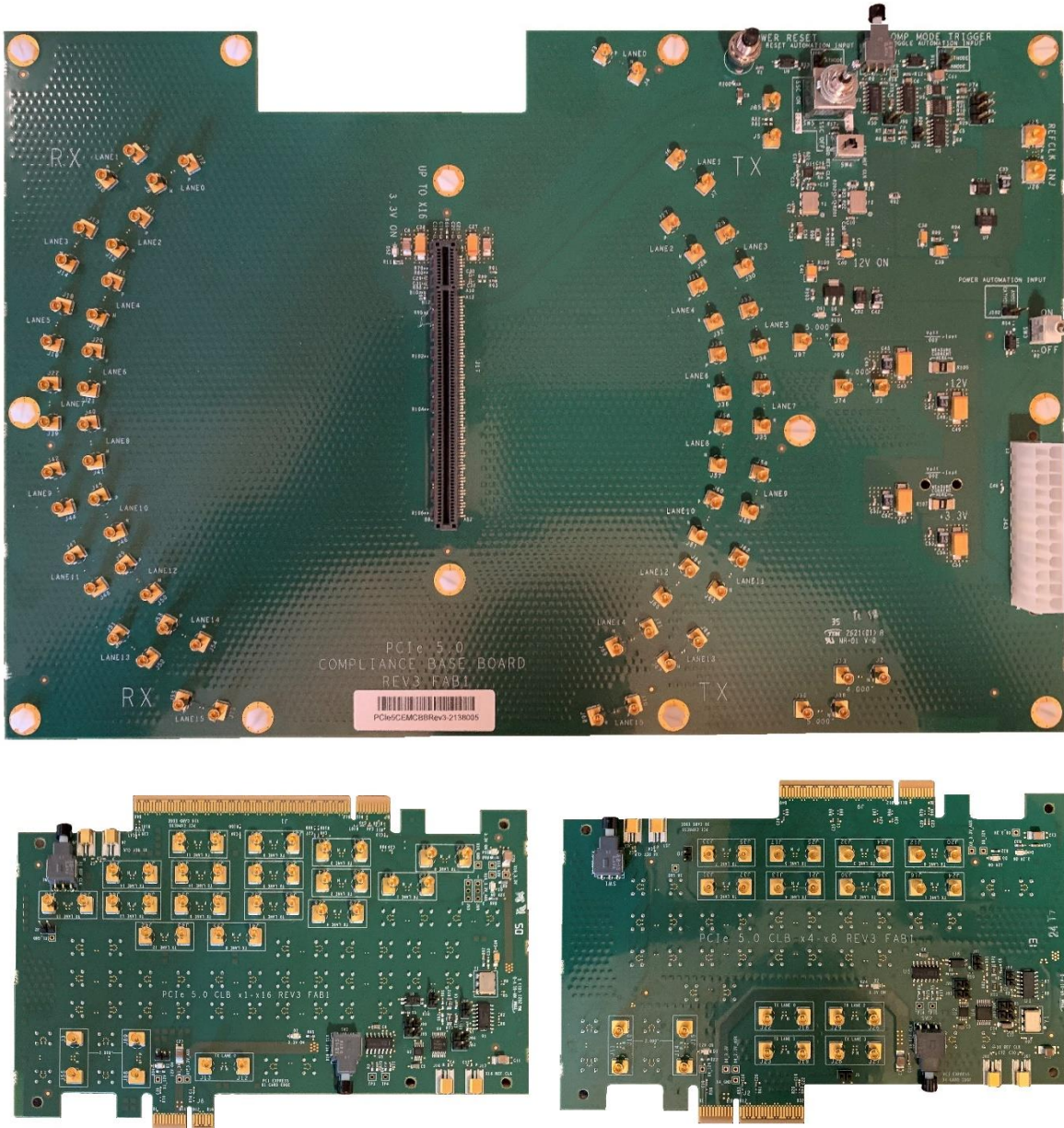

Figure 3. PCI-SIG CEM 5.0 CBB5, CLB5 (x1x16), and CLB5 (x4x8).

When doing CEM 5.0 testing it is necessary to characterize fixture and cable losses using a tool such as a VNA. Thus, to achieve the maximum die-pad to die pad losses it is necessary to select an s-parameter file which contains additional package model losses and trace losses. The D9050PCIC includes all of the CEM 5.0 s-parameter trace losses pre-configured as InfiniiSim transfer functions that can be applied to your signal quality CEM testing

Select the appropriate transfer function for the embedded losses you require.

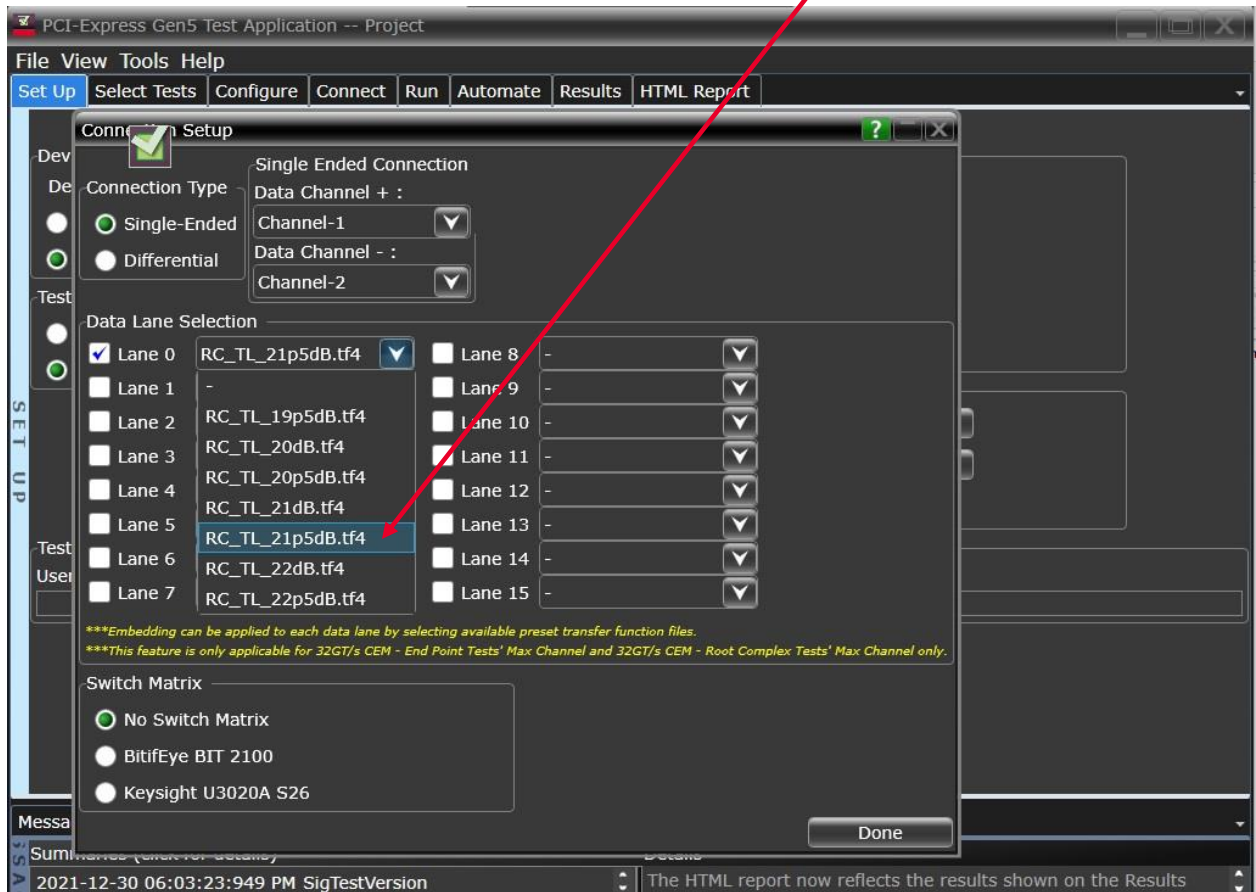

Figure 4. The D9050PCIC PCI Express 5.0 compliance application software includes pre-configured s-parameter loss functions to use when testing CEM add-in cards or motherboards at 32GT/s.

The D9050PCIC's Test Selection tab allows you to select the tests that you wish to perform on your device. Under the requirements of the PCIe 5.0 BASE and CEM specification limits, you can test devices at speeds ranging from 2.5GT/s to 32GT/s.

DUT automation (allowing for the selection of which data rate and compliance test signal the D9050PCIC will use for testing) can be configured via the DUT automation Toggle Setup.



Select the tests that you want to perform on your device according to each of the data rates it supports.

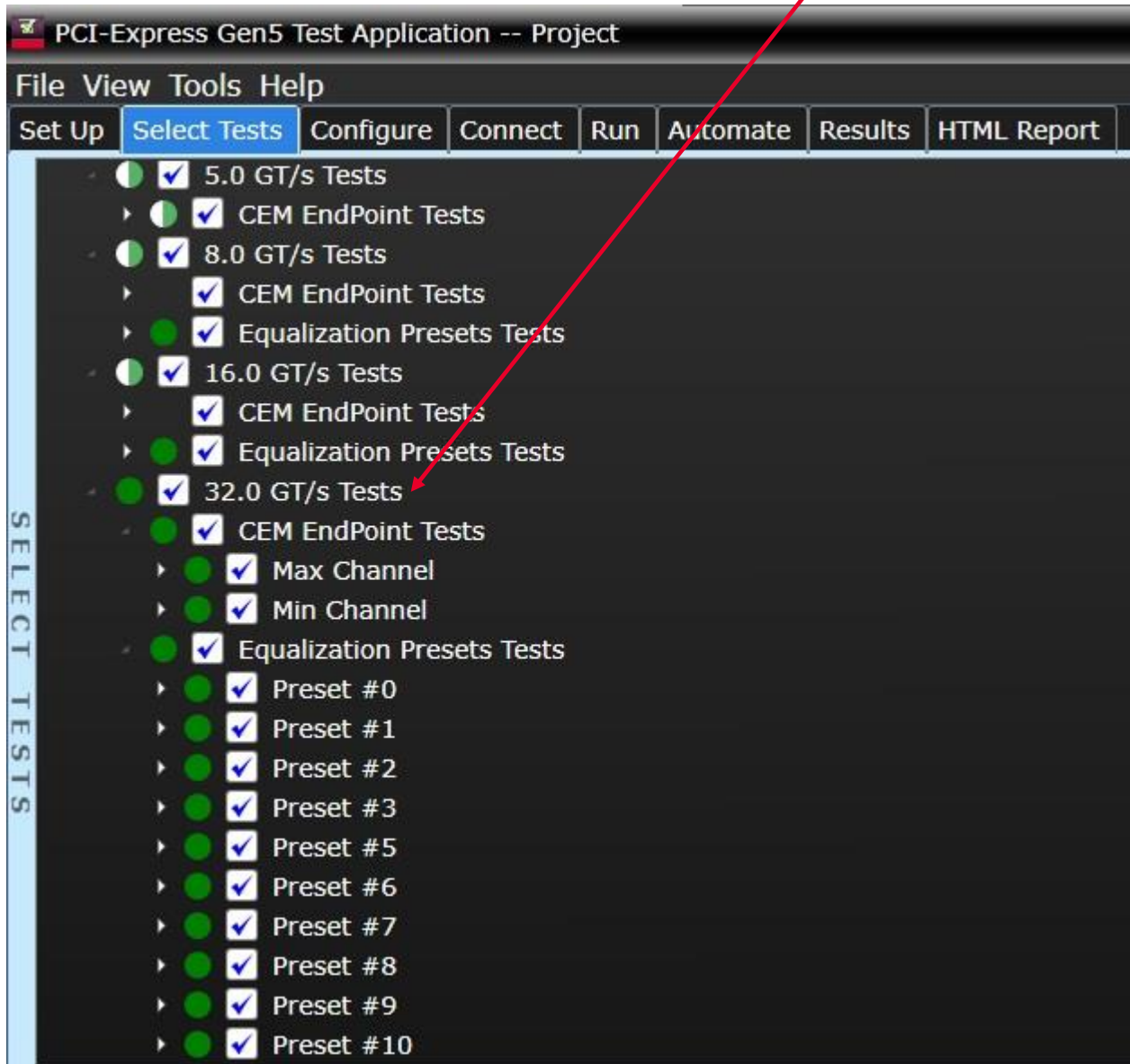

Figure 5. The D9050PCIC PCI Express 5.0 compliance application software allows you to easily select the specific tests you wish to run according to the maximum speed of your PCIe 5.0 device.

The D9050PCIC Test Connection Tab provides some helpful direction on how to connect your device and test fixture to your oscilloscope. This can be helpful as different configurations may be required depending on the type of device and the data rate at which your device is running.

You are prompted to make the appropriate connections for the tests you plan to execute.

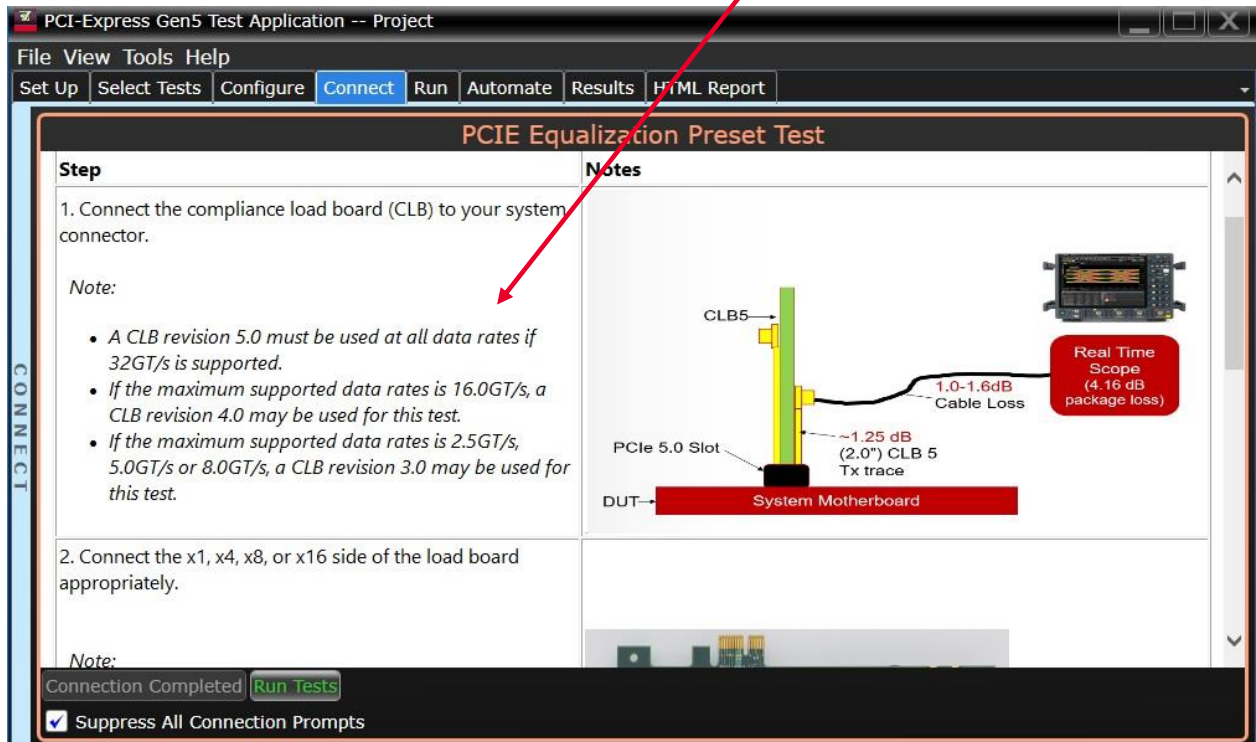

Figure 6. The D9050PCIC PCI Express 5.0 compliance application software includes connection diagrams to assist you with connecting your DUT to the oscilloscope.

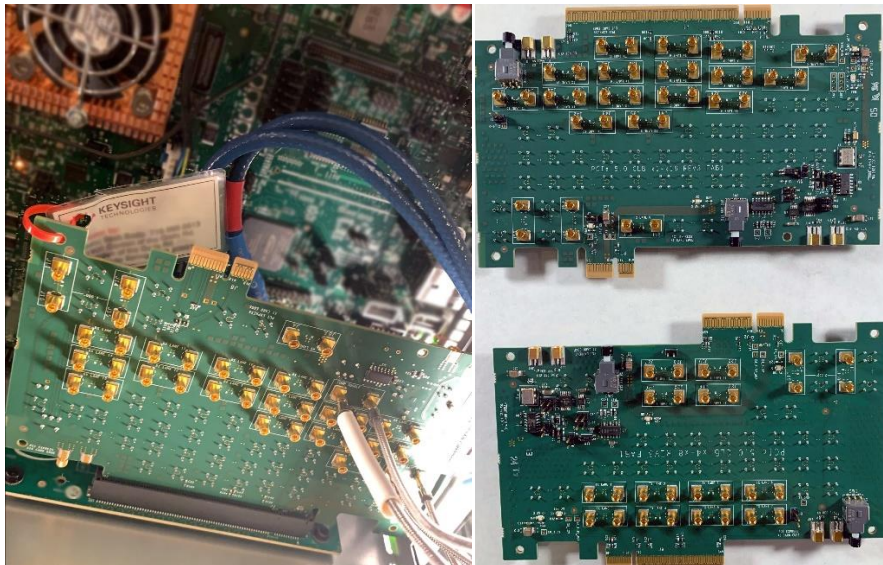

Figure 7. Using the connection diagrams, you can use the fixture and test connections appropriate for your device, data rate, and tests you have selected to be executed. A motherboard setup is shown here.

Reports with Margin Analysis

In addition to providing measurement results, the PCI Express electrical test software provides you with a report format that shows you not only where your product passes or fails, but also reports how close you are to the limits specified for a particular test assertion. You can select the margin test report parameter, which means you can specify the level at which warnings are issued to alert you to electrical tests where your product is operating close to the official test limits defined by the PCI Express 5.0 specification.

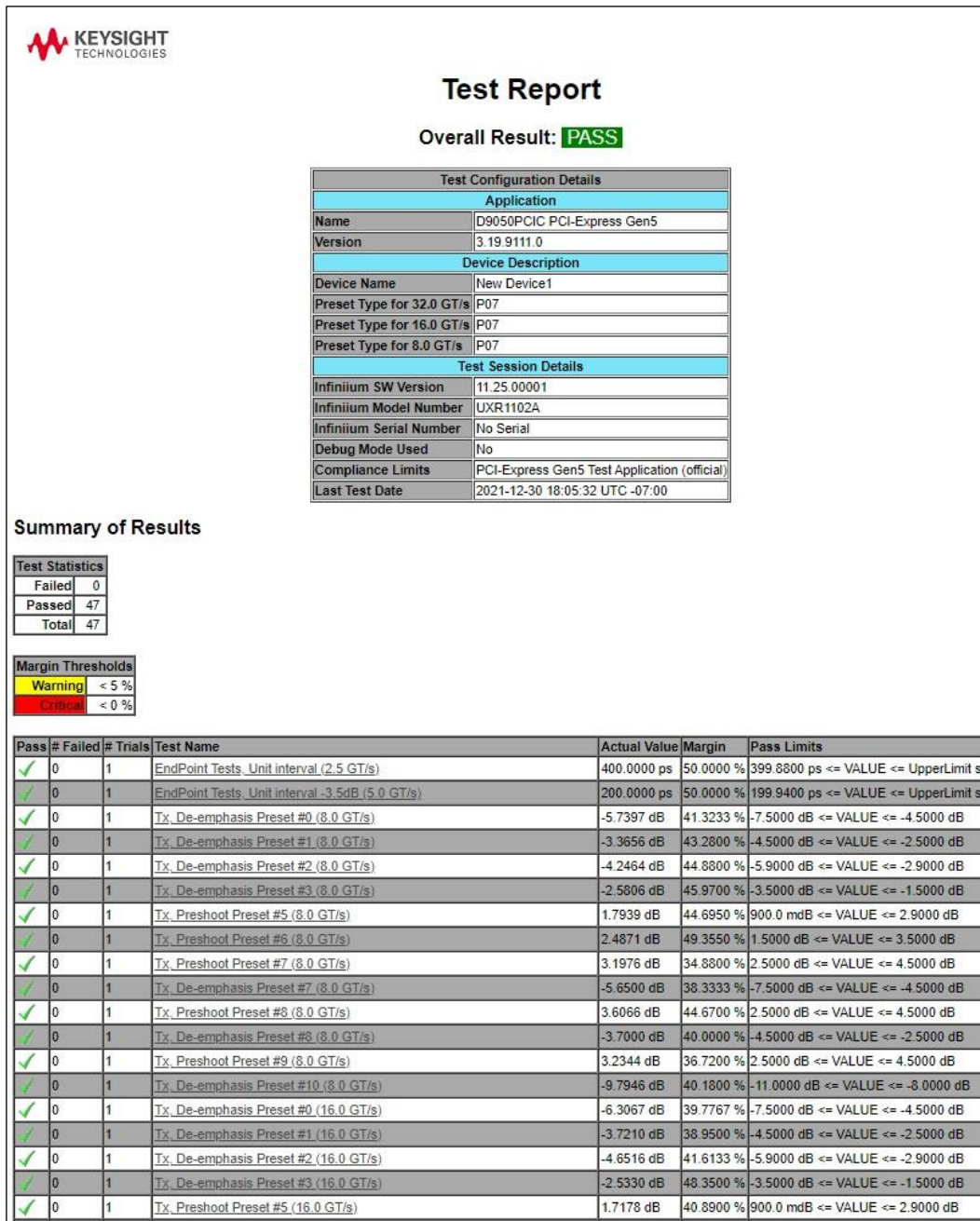

Figure 8. The D9050PCIC PCI Express 5.0 electrical test software results report documents your test results, indicates the pass/fail status, the measured values, and shows you how much margin you have.

Measurement Connection Requirements for BASE and CEM Spec Testing

The D9050PCIC PCI Express 5.0 electrical performance validation and compliance software requires the D9020JITA jitter, vertical and phase noise analysis software and the D9010DMBA InfiniiSim Basic (or D9020ASIA InfiniiSim advanced). In addition, you will need at least two phase-matched test cables of appropriate bandwidth. Some of the measurements performed by the D9050PCIC software require that you build or acquire a custom test board, assembly, or other test fixture for your DUT.

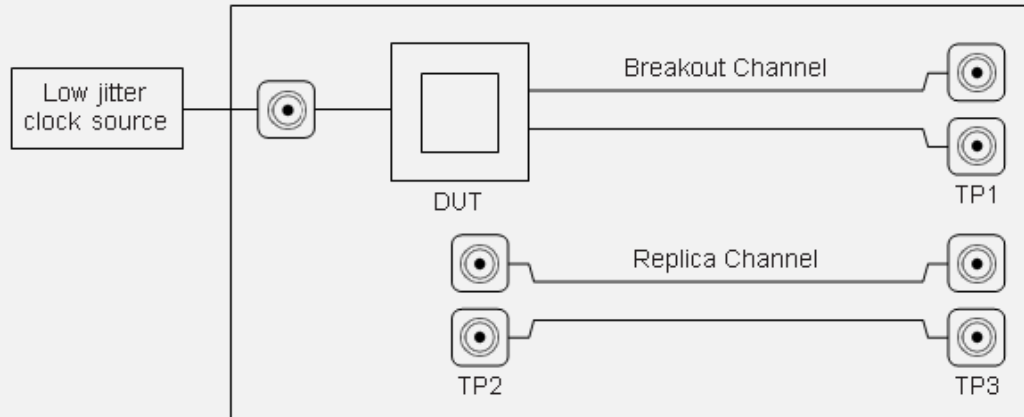

Figure 9. To test the transmitter of your PCIe 5.0 silicon, you will need to build or acquire a break-out board that allows you to connect high bandwidth test cables between your ASIC or DUT and your test instrumentation.

Bandwidth Requirements for PCIe 5.0 Tx Testing

PCI Express 5.0 technology operates at speeds up to 32 GT/s. The table below provides guidelines to the minimum bandwidth requirements for testing each speed of a PCI Express 5.0 device. While the maximum speed of any PCIe 5.0 is 32 GT/s, it is not required that a PCIe 5.0 support that speed; rather, a PCIe 5.0 device need only support any supported PCIe gear maximum but must support every intermediate speed up to that maximum including 2.5 GT/s.

In addition to transmitter measurements, phase jitter measurements of the PCIe 100 MHz reference clock also call for a minimum bandwidth of 5GHz be used to measure the clock. Use this information to help you select the proper oscilloscope for your specific requirements. Also, remember that receiver testing requires adequate bandwidth to ensure the most accurate calibration of your bit error ratio tester (BERT). Automated receiver calibration using the N5990A Automated Compliance and Device Characterization tool and the Keysight M8040A J-BERT high performance BERT includes integration and control of Keysight high performance oscilloscopes for fast BERT calibration for receiver stressed jitter and stressed voltage testing.

PCI Express bandwidth requirements by data rate for transmitter measurements and receiver calibration.

Data rate	TX bandwidth required	Minimum sample rate ⁴	Minimum bandwidth required for RX calibration
2.5 GT/s	6 GHz	20-256 GSa/s	12 GHz
5 GT/s	12 GHz	40-256 GSa/s	12 GHz
8 GT/s	12 GHz	40-256 GSa/s	25 GHz
16 GT/s	25 GHz	80-256 GSa/s	25 GHz
32 GT/s	33 GHz - 50 GHz ⁵	80-256GSa/s	50 GHz

Recommended Test Accessories

In Test accessories for PCIe 5.0 TX testing are largely dependent upon your test requirements, your test fixture design, and a host of other factors. Here are some Keysight products which may be useful.

Cables

40 GHz electrical (2.92 mm) (K connector) [mates with 3.5 mm]	
Part number	Description
N2812B	50-ohm cable, 2.92 mm (m-m) 1 meter
N2823A	50-ohm cable, 2.92 mm (m-m) matched pair 1 meter
N5448B	50-ohm cable, 2.92 mm (m-m) matched pair 25 cm

50 GHz electrical (2.4 mm)	
Part number	Description
N4910A	50-ohm cable, 2.4 mm (m-m), matched pair

67 GHz electrical (1.85 mm) (V connector) [mates with 2.4 mm]	
Part number	Description
N8045A-801	50-ohm cable, 1.85 mm (M-m) \pm 1 ps 0.16 m
N2814A	50-ohm cable, 1.85 mm (m-m) 1 meter

4. Use a sample rate sufficient to minimize noise for your model of oscilloscope.
5. BASE testing at 32GT/s requires a minimum oscilloscope BW of 50GHz. For CEM testing at 32GT/s, 33GHz min is required.

Ordering Information

Required hardware and software

D9050PCIC is compatible with Z-Series and UXR Series oscilloscopes having a minimum of two channels, with software version 6.30 or greater. Motherboard CEM testing at 5GT/s, 8GT/s and 16GT/s will require you capture both data and clock signals (dual port) requiring 4 channels.

The D9050PCIC PCI Express 5.0 electrical performance validation and compliance software requires the D9020JITA jitter, vertical and phase noise analysis software and the D9010DMBA InfiniiSim Basic (or D9020ASIA InfiniiSim advanced) for de-embedding fixture break-out channels or for embedding package model and channel losses.

D9050PCIC PCI Express compliance software with D9010AGGC Compliance Test Measurement Server license

Model number	Description	Quantity
D9050PCIC	PCIe Gen5 compliance app software <i>Note:</i> PCIe 5.0 devices with 16 GT/s max speed tested to PCIe 4.0 TX limits	1 <i>Note:</i> To be installed and licensed on the Infiniium scope.
D9010AGGC	Measurement Server license	1 or 2 or 3 <i>Note:</i> To be installed on a virtual machine. 1 license/virtual machine. Quantity of servers needed depends on the desired speed improvement. More servers will improve test throughput.
KS8108A	Resource Arbiter Server	1 <i>Note:</i> To be installed and licensed on the Infiniium scope

Flexible Software Licensing and KeysightCare Software Support Subscriptions

Keysight offers a variety of flexible licensing options to fit your needs and budget. Choose your license term, license type, and KeysightCare software support subscription.

License Terms

Perpetual – Perpetual licenses can be used indefinitely.

Subscription – Subscription licenses can be used through the term of the license only (6, 12, 24, or 36 months).

License Types

Node-locked – License can be used on one specified instrument/computer.

Transportable – License can be used on one instrument/computer at a time but may be transferred to another using Keysight Software Manager (internet connection required).

USB Portable – License can be used on one instrument/computer at a time but may be transferred to another using a certified USB dongle (available for additional purchase with Keysight part number E8900-D10).

Floating (single site) – Networked instruments/computers can access a license from a server one at a time. Multiple licenses can be purchased for concurrent usage.

KeysightCare Software Support Subscriptions

Perpetual licenses are sold with a 12 (default), 24, 36, or 60-month software support subscription. Support subscriptions can be renewed for a fee after that.

Subscription licenses include a software support subscription through the term of the license.

Selecting your license

Step 1. Choose your software product (eg. S1234567A).

Step 2. Choose your license term: perpetual or subscription.

Step 3. Choose your license type: node-locked, transportable, USB portable, or floating.

Step 4. Depending on the license term, choose your support subscription duration.

KeysightCare Software Support Subscription provides peace of mind amid evolving technologies.

- Ensure your software is always current with the latest enhancements and measurement standards.
- Gain additional insight into your problems with live access to our team of technical experts.
- Stay on schedule with fast turnaround times and priority escalations when you need support.

Subscription-based Compliance Test Software Suites

Keysight now offers an ownership model of multiple Compliance Test Software applications.

With this new subscription-based model, the PCIe software suites bundle the Compliance Test Software Applications under a model number. Using a subscription-based ownership, you can enjoy all the test software features covered under PCIe across multiple generations and variants.

Software support and continuity

Under the subscription plan, software support is made available with no extra support cost. Ensuring your software always stays up to date with the latest enhancements and measurement standards while having access to our team of technical experts when you need support.

On top of that all upgrades are made available to you as the PCIe standards progresses with no additional costs.

Subscription-based Compliance Test Software Suites

Each suite comes with a 12, 24, or 36-month software suite subscription.

Model Number	Options Available
SW00PCIE PCIe Validation License	PCIe 3.0/4.0 TX Validation (D9040PCIC) PCIe 5.0 TX Validation (D9050PCIC)
SW02PCIE PCIe PCI Express Full Tx Test Suite	PCIe 3.0/4.0 TX Validation (D9040PCIC) PCIe 5.0 TX Validation (D9050PCIC) PCIe Advanced Protocol Decode/Trigger (D9010PCIE)

Learn more at: www.keysight.com

For more information on Keysight Technologies' products, applications or services, please contact your local Keysight office. The complete list is available at: www.keysight.com/find/contactus

