

Easily Verify USB Electrical Parameters

The N5416A USB compliance test software for Infiniium oscilloscopes gives you a fast and reliable way to verify USB electrical specification compliance for your USB 2.0 devices, hosts and hubs. The software executes the official USB-IF software, USBET20 embedded in the oscilloscope.

- Easy-to-use interface for fast setup, configuration and automated test
- Recognized by the USB-IF for USB compliance testing
- Award-winning Infiniium ease of use
- Test fixtures for USB 1.1 (low- and full-speed), USB 2.0 (high-speed)

With USB compliance test software, you can take the Infiniium oscilloscope you use for everyday debugging and use it to verify USB electrical parameters with the same testing scripts the USB-IF created for official compliance testing at designated workshops. The USB compliance test software has a new setup wizard that allows you to quickly and easily test all facets of electrical compliance of your device, host or hub. The setup wizard menu structure of the N5416A USB test option provides a level of simplicity not found with other vendors multi-tiered menu structures for executing tests and documenting results.

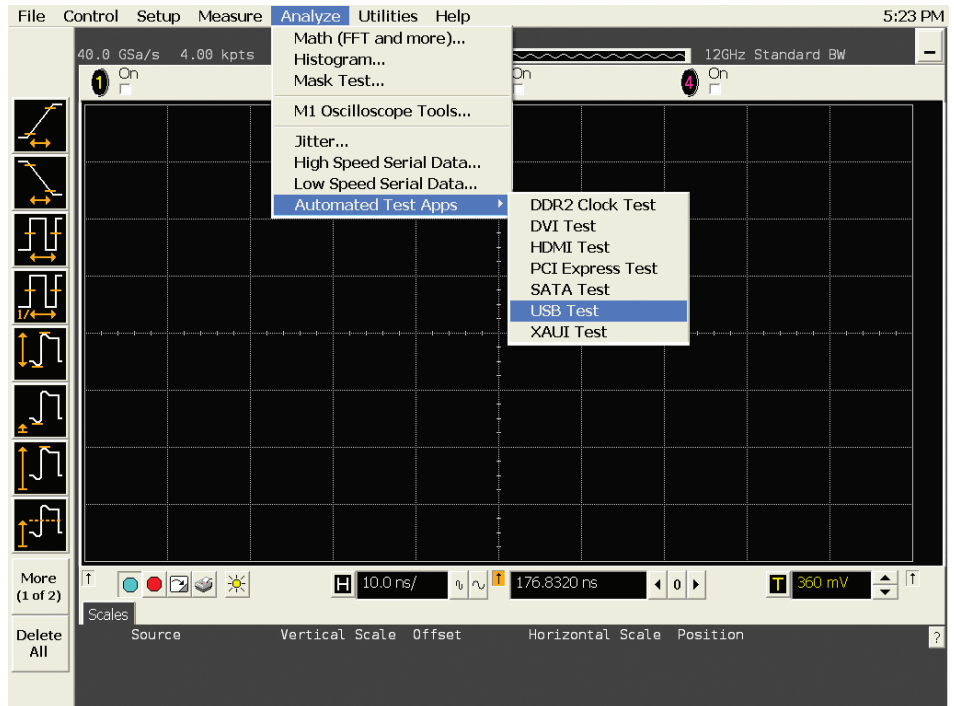

Figure 1. The Infiniium USB compliance tests are incorporated directly into the oscilloscope's menu structure as a submenu under the Analyze menu.

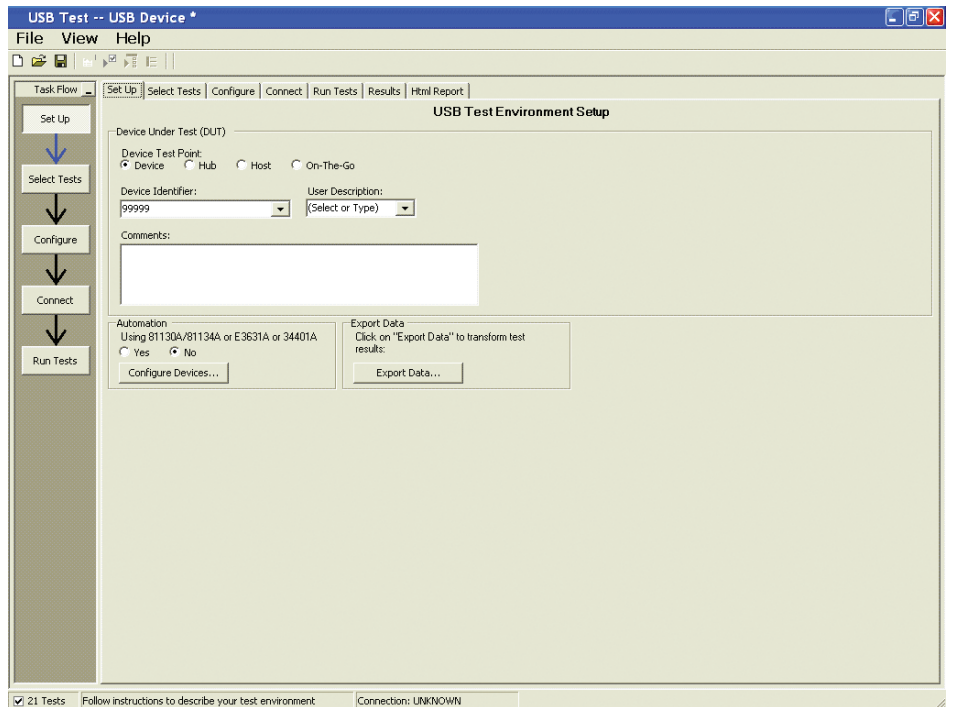

Figure 2. You can configure and launch the Infiniium USB compliance tests through a single window.

Easily Verify USB Electrical Parameters (continued)

Low-, full- and high-speed tests require compliance with signal quality, inrush current, droop, drop, and backdrive voltage tests. Hi-speed USB requires compliance with an additional suite of tests. These tests are provided by the USB compliance test software. Tests can be executed directly from the scope interface under the Analyze menu.

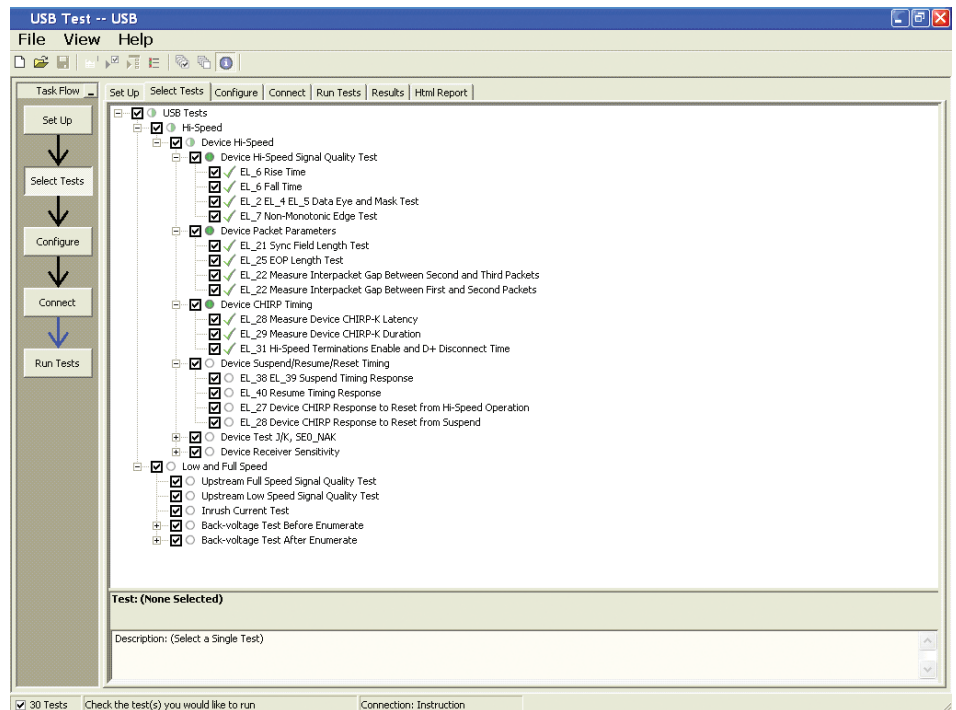

Figure 3. You can select individual tests or the entire list of compliance tests from a single window page.

Benefits

In the past, pre-compliance testing in a lab environment involved capturing data with an oscilloscope, transferring it to a PC and post-processing it with a software program. Keysight Technologies, Inc. has simplified the process by installing a run-time version of MATLAB software in the scope and integrating the USB test option into the Infiniium oscilloscope's menu structure.

Once the test is executed, the test results appear on the Infiniium display in an HTML-formatted window.

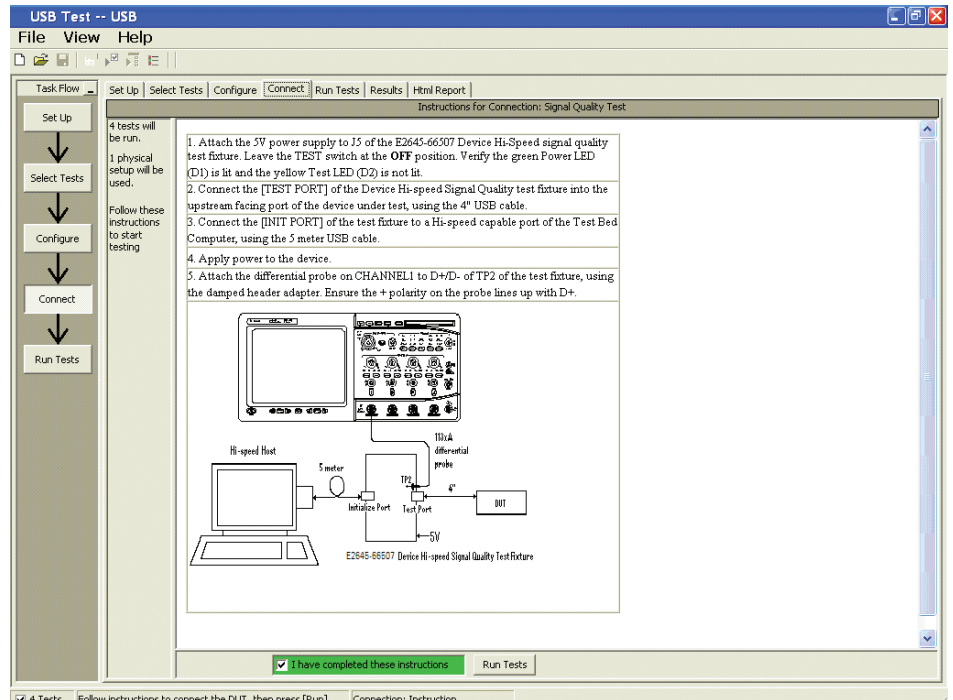

Figure 4. Test instructions and diagrams are included to help you configure your equipment.

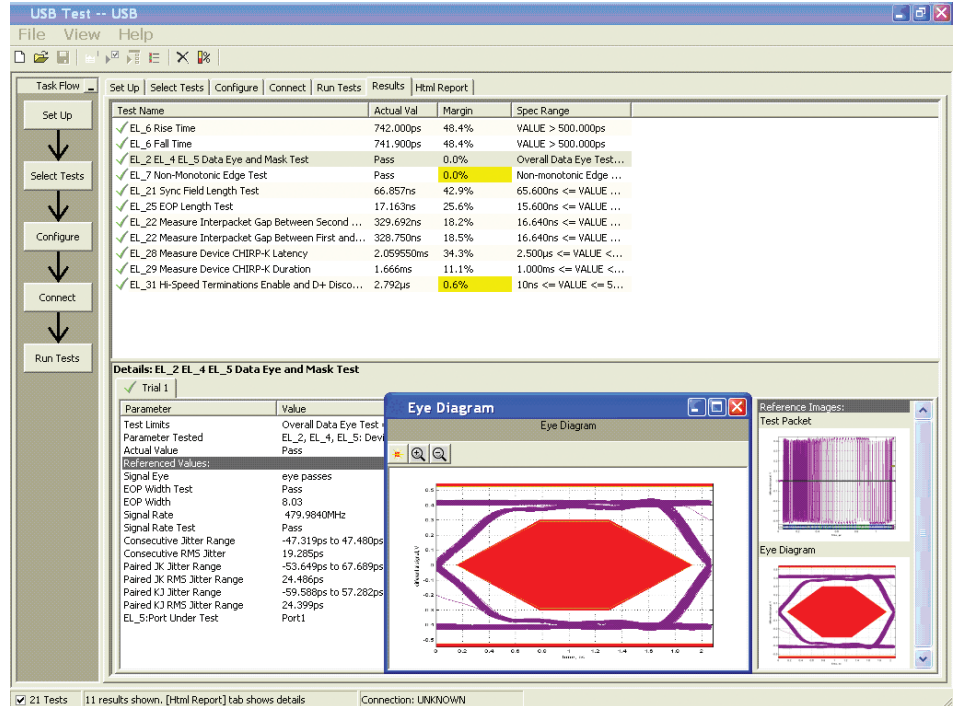

Figure 5. Infiniium scopes automatically display test results in an html window immediately after test execution.

Benefits (continued)

Each test also automatically saves the PNG, HTML, and TSV files required by the USB-IF. The higher data rates associated with hi-speed USB 2.0 demand a measurement system that will not interfere with your device/host/hub operation by loading the system. The award-winning InfiniiMax probing system, which is compatible with Infiniium oscilloscopes, provides unmatched signal fidelity – ensuring your measurement system does not load the signals under test – so it does not compromise the specification margins for passing the electrical signal quality tests. The InfiniiMax probing system has been approved by the USB-IF for compliance testing. The set of six high-speed test fixtures are highly manageable in a test environment due to their small size. The six fixtures allow you the flexibility to run different tests concurrently when you have more than one host, hub, or device to verify for compliance.

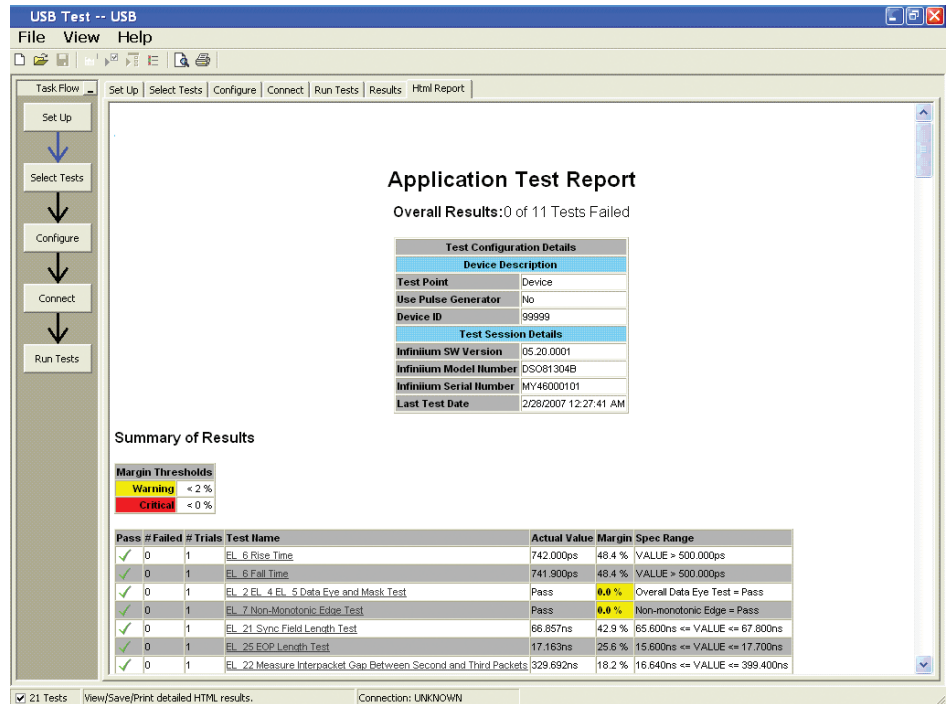

Figure 6. The results are stored in a printable HTML report.

Extensibility

You may add additional custom tests or steps to your application using the N5467A User-Defined Application (UDA) development tool (www.keysight.com/find/uda). Use UDA to develop functional “Add-Ins” that you can plug into your application.

Add-ins may be designed as:

- Complete custom tests (with configuration variables and connection prompts)
- Any custom steps such as pre or post processing scripts, external instrument control and your own device control

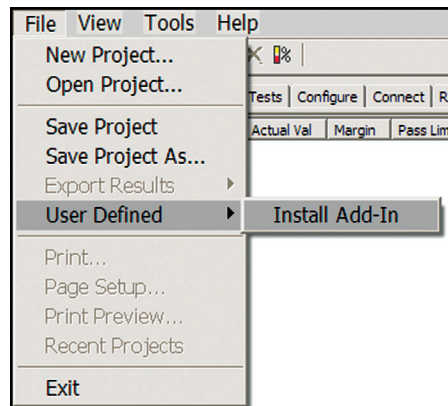

Figure 7. Importing a UDA Add-In into your test application.

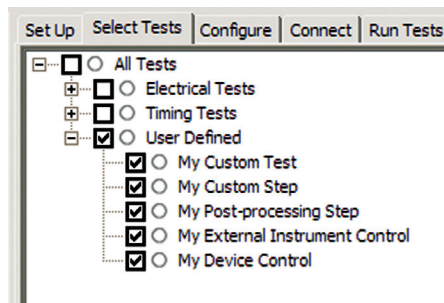

Figure 8. UDA Add-In tests and utilities in your test application.

Automation

You can completely automate execution of your application's tests and Add-Ins from a separate PC using the included N5452A Remote Interface feature (download free toolkit from www.keysight.com/find/scope-apps-sw). You can even create and execute automation scripts right inside the application using a convenient built-in client.

The commands required for each task may be created using a command wizard or from "remote hints" accessible throughout the user interface. Using automation, you can accelerate complex testing scenarios and even automate manual tasks such as:

- Opening projects, executing tests and saving results
- Executing tests repeatedly while changing configurations
- Sending commands to external instruments
- Executing tests out of order

Combine the power of built-in automation and extensibility to transform your application into a complete test suite executive:

- Interact with your device controller to place it into desired states or test modes before test execution.
- Configure additional instruments used in your test suite such as a pattern generator and probe switch matrix.
- Export data generated by your tests and post-process it using your favorite environment, such as MATLAB, Python, LabVIEW, C, C++, Visual Basic etc.
- Sequence or repeat the tests and "Add-In" custom steps execution in any order for complete test coverage of the test plan.

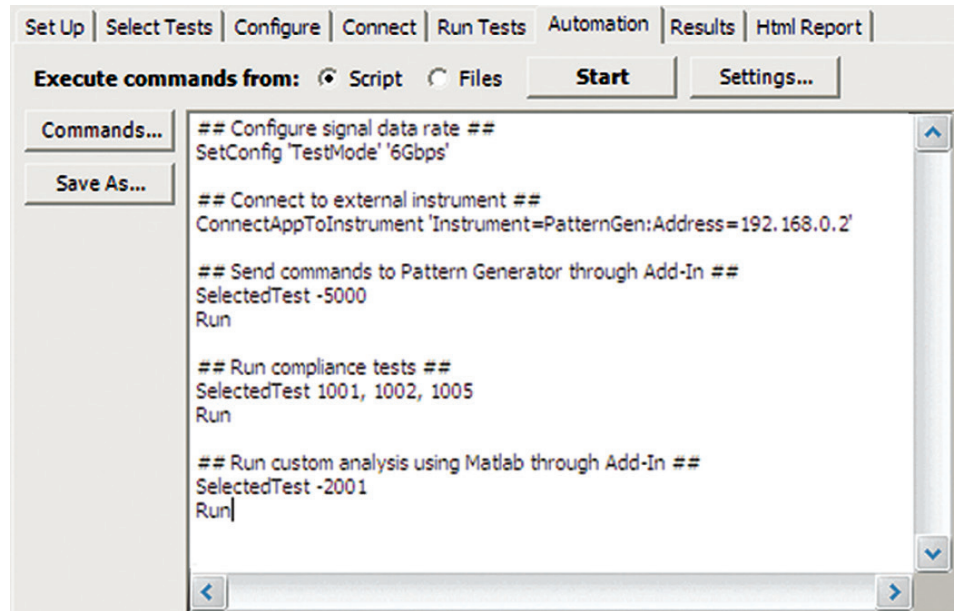

Figure 9. Remote programming script in the Automation tab.

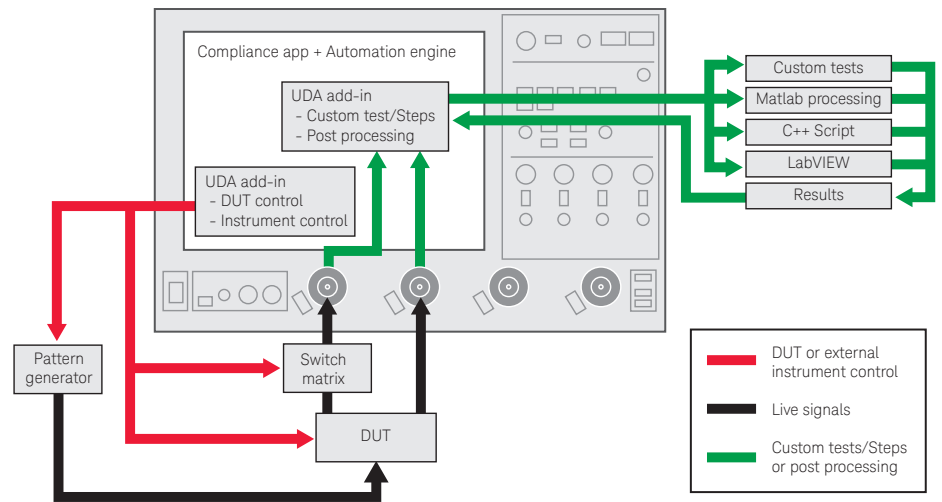

Figure 10. Combine the power of built-in automation and extensibility to transform your application into a complete test suite executive.

Recommended Test Equipment

The N5416A USB test option requires an Infiniium 4-channel or 4+16 channel oscilloscope. To run hi-speed USB compliance tests, you will need E2649A/E2649B fixtures. For low/full-speed tests, you will need a E2646B SQuIDD test fixture.

No fixtures are supplied with the N5416A software. One SQuIDD test fixture must be ordered separately as part number E2646B (for low- and full-speed testing). A set of six high-speed test fixtures for signal quality, receiver sensitivity, TDR, and host disconnect must be ordered separately as part number E2649B.

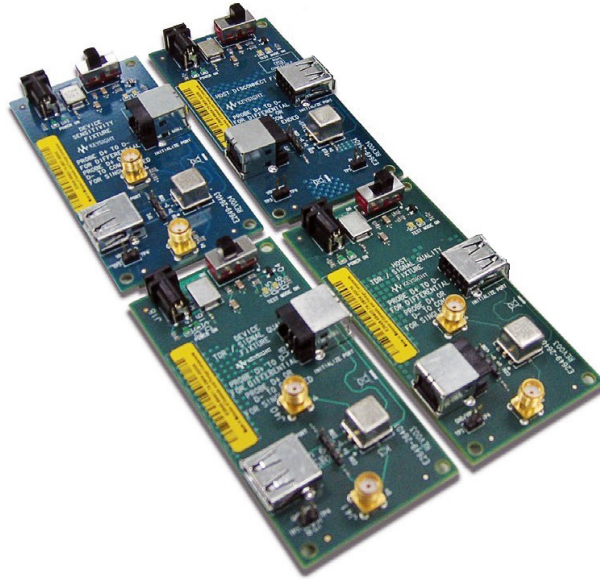

Figure 11. E2649B test fixture.

Recommended high-speed test equipment ¹

Infiniium Series oscilloscope (recommended bandwidth: 2 GHz or higher)

Model or part number	Description	Quantity
N5416A	USB 2.0 low-/full-/high-speed test option for Infiniium oscilloscopes 90000A X90000A/Q, V and Z 1	1
N5416B	USB 2.0 low-/full-/high-speed test option for Infiniium oscilloscopes 9000A, S-series ¹	1
E2649B	Hi-speed USB 2.0 test fixture set consists of: <ul style="list-style-type: none"> - E2649-66401 device TDR/signal quality test fixture - E2649-66402 host TDR/signal quality test fixture - E2649-66403 device receiver sensitivity fixture - E2649-66404 host disconnect test fixture Note: A droop and drop test fixture is also required. Contact the USB-IF for current available products.	1
1131B/32B/34B	InfiniiMax probe amplifier (qty 2 required for hub testing)	1
N5442A	InfiniiMax III 3.5 mm to precision BNC adapter (required for the 90000 X-Series)	3
E2678A	Differential socketed probe head for InfiniiMax probe amplifiers (qty 2 required for hub testing)	1
Digital signal generator ²	81160A Pulse Function Arbitrary Noise Generator With options: <ul style="list-style-type: none"> - #002 2-channel function arbitrary noise generator - #660 License for 660 Mbit/s pattern generator - BNC to SMA adapter and Male SMA cable Or 81134A pulse generator: <ul style="list-style-type: none"> - 15433B 500 ps transition time converter (for use with the 81134A) - Male SMA cable 	2 2 2
82357B ⁴	USB-to-GPIB interface converter	
TDR4	86100A/B/C	1
	54754A	1
	Male SMA cable	2
USB-IF tool on host system ³	HS electrical test tool available from www.usb.org (USBHSET.exe)	1

1. High-speed devices must support the full-speed mode. Consult the “Recommended low/full-speed test equipment” table for the required test equipment.

2. A digital signal generator is required when testing receiver sensitivity for devices/hubs.

3. Not available from Keysight. Refer to www.usb.org for lists of qualified vendors.

(Note that four damped adapters are included with the E2649A)
 (The damped adapter part number is 01130-63201)

Recommended Test Equipment (continued)

Recommended low-/full-speed test equipment ¹

With Keysight Infiniium Series or 54830B/D, 54832A/D oscilloscopes.

Model or part number	Description	Quantity
N5416A	USB 2.0 low-/full-/high-speed test option for Infiniium oscilloscopes	1
E2646B	One SQuIDD (signal quality inrush, drop/droop) test fixture for low-/full-speed USB 2.0 testing	1
E2697A	High-impedance adapter with one 10073C passive probe (for the 90000A Series oscilloscopes)	3
10075A	Clip adapter (for each E2697A)	3
8710-2063	Dual lead adapters	3
1147B	50-MHz current probe (for 8000, 54831B/D or 32B/D only)	1
N2782A and N2779A ²	50-MHz 30 A current probe and 3-channel power supply	1
USB host system	Refer to http://compliance.usb.org/Interoperability	1
USB cable	5-meter cable	6
	1-meter cable	1
USB-IF tool on	HS electrical test tool available from www.usb.org (USBHSET.exe)	1

1. High-speed devices must support the full-speed mode. Consult the "Recommended low/full-speed test equipment" table for the required test equipment.
2. N2774A and N2775A are obsolete and replaced with N2779A and N2782A.

Infiniium Series USB 2.0 Compliance Test Application Capabilities (continued)

The following table summarizes the features of Keysight's various USB test analysis options in InfiniiVision 4000 and 6000 X-Series and Infiniium oscilloscopes:

Table 1. USB Testing coverage comparison

USB measurement	Signal integrity testing with InfiniiVision 4000/6000X with the USBSQ option	Complete USB-IF electrical compliance testing with Infiniium S-Series N5416A/B option
EL_2 EL_4 EL_5 Data Eye and Mask Test High speed SQ	√	√
Consecutive, paired JK, and paired KJ jitter	√	√
Full and Low speed signal quality	√	√
Sync test	√	√
Cross-over voltage (low- and full-speed only)	√	√
EOP bit-width	√	√
Signaling rate	√	√
EL_6 Device Rise and Fall Time	√ ¹	√
Edge rate match (low- and full-speed only)	√	√
HTML pass/fail report generation	√	√
EL_7 Device Non-Monotonic Edge Test	√	√
EL_22 Interpacket Gap Tests		√
EL_28 Chirp-K Latency		√
EL_29 Device CHIRP-K Duration		√
EL_31 Host Hi-Speed Terminations Enable and D+ Disconnect Time		√
EL_38 EL_39 Device Suspend Timing Response		√
EL_40 Device Resume Timing Response		√
EL_27 Device CHIRP Response to Reset from Hi-Speed Operation		√
EL_28 Device CHIRP Response to Reset from Suspend		√
EL_8 Device J Test		√
EL_8 Device K Test		√
EL_9 Device SEO_NAK Test		√
Inrush Current Test		√
Drop/Droop Vbus tests		√
VBus Backdrive tests		√

1. To accurately measure USB 2.0 rise and fall times with less than 10% error for sub 500 ps edges the measurement BW must be at least 2.5 GHz as required for official USB-IF compliance testing.

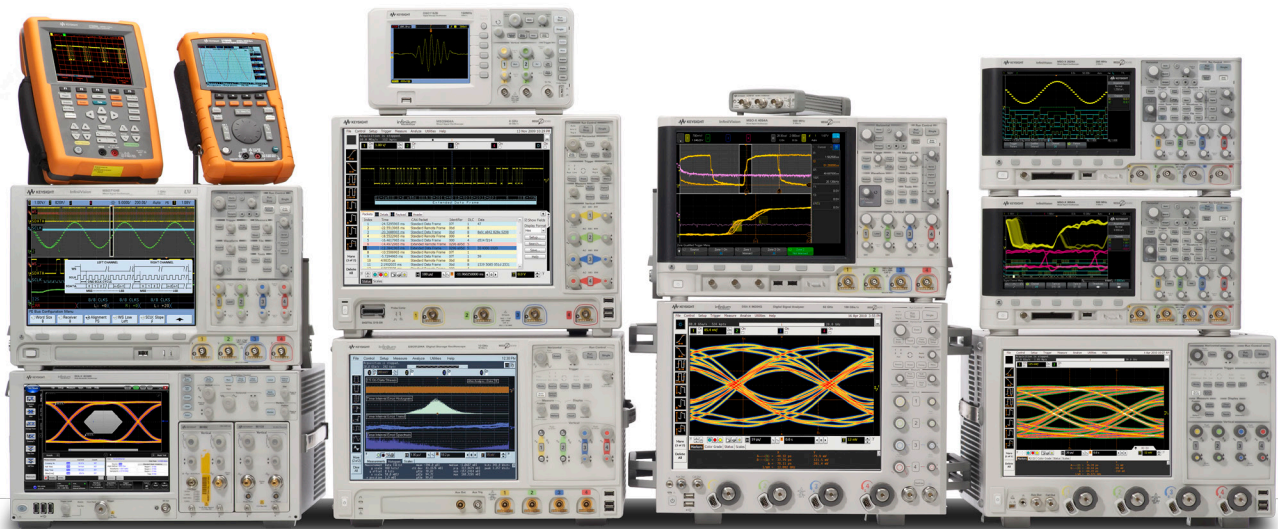

Keysight Oscilloscopes

Multiple form factors from 20 MHz to > 90 GHz | Industry leading specs | Powerful applications

Learn more at: www.keysight.com

For more information on Keysight Technologies' products, applications or services, please contact your local Keysight office. The complete list is available at: www.keysight.com/find/contactus

