

DATA SHEET

# E4991B Impedance Analyzer

1 MHz to 500 MHz/1 GHz/3 GHz



## Definitions

### Specification (spec.)

Warranted performance. All specifications apply at  $23\text{ °C} \pm 5\text{ °C}$  unless otherwise stated, and 30 minutes after the instrument has been turned on. Specifications include guard bands to account for the expected statistical performance distribution, measurement uncertainties, and changes in performance due to environmental conditions.

### Typical (typ.)

Expected performance of an average unit which does not include guardbands. It is not covered by the product warranty.

### Nominal (nom.)

A general, descriptive term that does not imply a level of performance. It is not covered by the product warranty.

## Measurement Parameters and Range

### Measurement parameters

Impedance parameters:

$|Z|, |Y|, L_s, L_p, C_s, C_p, R_s(R), R_p, X, G, B, D, Q, \theta_z, \theta_y, |\Gamma|, \Gamma_x, \Gamma_y, \theta_r, V_{ac}, I_{ac}, V_{dc}, I_{dc}$   
(Option E4991B-001 only)

Material parameters (Option E4991B-002):

(see "Option E4991B-002 material measurement (typical)" on page 19)

Permittivity parameters:  $|\epsilon_r|, \epsilon_r', \epsilon_r'', \tan\delta$

Permeability parameters:  $|\mu_r|, \mu_r', \mu_r'', \tan\delta$

### Measurement range

Measurement range ( $|Z|$ ):

120 m $\Omega$  to 52 k $\Omega$

(Frequency = 1 MHz,

Point averaging factor  $\geq 8$ ,

Oscillator level = -3 dBm; or = -13 dBm,

Measurement accuracy  $\leq \pm 10\%$ ,

Calibration is performed within  $23\text{ °C} \pm 5\text{ °C}$ ,

Measurement is performed within  $\pm 5\text{ °C}$  of calibration temperature)

## Source Characteristics

### Frequency

Range: 1 MHz to 3 GHz (Option 300)

1 MHz to 1 GHz (Option 100)

1 MHz to 500 MHz (Option 050)

Resolution: 1 mHz

Accuracy:

without Option E4991B-1E5:

$\pm 10$  ppm ( $23\text{ °C} \pm 5\text{ °C}$ )

$\pm 20$  ppm ( $5\text{ °C}$  to  $40\text{ °C}$ )

with Option E4991B-1E5:

$\pm 1$  ppm ( $5\text{ °C}$  to  $40\text{ °C}$ )

Stability:

with Option E4991B-1E5:

$\pm 0.5$  ppm/year (5 °C to 40 °C) (typical)

## Oscillator level

Range:

Power (when 50  $\Omega$  load is connected to test port):

-40 dBm to 1 dBm

Current (when short is connected to test port):

0.0894 mArms to 10 mArms

Voltage (when open is connected to test port):

4.47 mVrms to 502 mVrms

Resolution: 0.1 dB <sup>1</sup>

Accuracy:

(Power, when 50  $\Omega$  load is connected to test port)

Frequency  $\leq 1$  GHz:

$\pm 2$  dB (23 °C  $\pm 5$  °C)

$\pm 4$  dB (5 °C to 40 °C)

Frequency  $> 1$  GHz:

$\pm 3$  dB (23 °C  $\pm 5$  °C)

$\pm 5$  dB (5 °C to 40 °C)

with Option 010:

Frequency  $\leq 1$  GHz

Minimum: -3 dB, Maximum: +2 dB (23 °C  $\pm 5$  °C)

Minimum: -5 dB, Maximum: +4 dB (5 °C to 40 °C)

Frequency  $> 1$  GHz

Minimum: -4 dB, Maximum: +3 dB (23 °C  $\pm 5$  °C)

Minimum: -6 dB, Maximum: +5 dB (5 °C to 40 °C)

## Output impedance

Output impedance: 50  $\Omega$  (nominal)

## DC Bias (Option E4991B-001)

### DC voltage bias

Range: 0 to  $\pm 40$  V

Resolution: 1 mV

Output impedance (series): 15  $\Omega$  (typical)

Accuracy:

$\pm \{0.05\% + 5 \text{ mV} + (|I_{dc}[\text{mA}]| \times 20 \Omega)\}$  (23 °C  $\pm 5$  °C)

$\pm \{0.2\% + 10 \text{ mV} + (|I_{dc}[\text{mA}]| \times 40 \Omega)\}$  (5 °C to 40 °C)

Current limit range: 1mA to 100mA (both source and sink are limited to same current.)

Current limit resolution: 2  $\mu$ A

Current limit accuracy:  $\pm 4\%$  (5 °C to 40 °C, typical)

1. When the unit is set at mV or mA, the entered value is rounded to 0.1 dB resolution.

## DC current bias

Range: 0 to 100 mA

Resolution: 2  $\mu$ A

Output impedance (shunt): 20 k $\Omega$  minimum (typical)

Accuracy:

$\pm \{0.2\% + 20 \mu\text{A} + (|V_{\text{dc}}[\text{V}]|/10 \text{ k}\Omega)\}$  (23 °C  $\pm$  5 °C)

$\pm \{0.4\% + 40 \mu\text{A} + (|V_{\text{dc}}[\text{V}]|/5 \text{ k}\Omega)\}$  (5 °C to 40 °C)

Voltage limit range: 0.3 V to 40 V (both positive and negative sides are limited to same voltage.)

Voltage limit resolution: 1 mV

Voltage limit accuracy:  $\pm (2\% + 20 \text{ mV} + |I_{\text{dc}}| \times 20 \Omega)$  (5 °C to 40 °C, typical)

## DC bias monitor

Monitor parameters: Voltage and current

Voltage monitor accuracy:

$\pm \{0.2\% + 10 \text{ mV} + (|I_{\text{dc}}[\text{mA}]| \times 2 \Omega)\}$

(23 °C  $\pm$  5 °C, typical)

$\pm \{0.8\% + 24 \text{ mV} + (|I_{\text{dc}}[\text{mA}]| \times 4 \Omega)\}$

(5 °C to 40 °C, typical)

Current monitor accuracy:

$\pm \{0.2\% + 25 \mu\text{A} + (|V_{\text{dc}}[\text{V}]|/40 \text{ k}\Omega)\}$

(23 °C  $\pm$  5 °C, typical)

$\pm \{0.8\% + 60 \mu\text{A} + (|V_{\text{dc}}[\text{V}]|/20 \text{ k}\Omega)\}$

(5 °C to 40 °C, typical)

## Sweep Characteristics

Sweep conditions:

Linear frequency, log frequency, OSC level (voltage, current, power), DC bias (voltage, current), log DC bias (voltage, current), segment

Sweep range setup: Start/stop or center/span

Sweep mode: Continuous, single

Sweep directions:

up sweep, down sweep

Number of measurement points: 2 to 1601

Delay time:

Types: point delay, sweep delay, segment delay

Range: 0 to 30 sec

Resolution: 1 msec



## Segment sweep

Available setup parameters for each segment:

Sweep frequency range, number of measurement points, point averaging factor, oscillator level (power, voltage, or current), DC bias (voltage or current), segment time, segment delay.

Number of segments: 1 to 201

Sweep span types: Frequency base or order base

## Measurement Accuracy

### Conditions for defining accuracy

Temperature: 23 °C ± 5 °C <sup>1</sup>

Accuracy-specified plane: 7-mm connector of test head

Accuracy defined measurement points:

- Same points at which the calibration is done. <sup>2</sup>

### Basic accuracy (Typical)

0.45%

Accuracy when open/short/load calibration is performed

$|Z|, |Y|:$   $\pm(E_a + E_b)$  [%]  
(see Figures 1 through 4  
for examples of  
calculated accuracy)

$\theta:$   $\pm \frac{(E_a + E_b)}{100}$  [rad]

L, C, X, B:  $\pm (E_a + E_b) \times \sqrt{(1 + D_x^2)}$  [%]

R, G:  $\pm (E_a + E_b) \times \sqrt{(1 + Q_x^2)}$  [%]

D:  
at  $\left| D_x \tan \left( \frac{E_a + E_b}{100} \right) \right| < 1$   $\pm \frac{(1 + D_x^2) \tan \left( \frac{E_a + E_b}{100} \right)}{1 \mp D_x \tan \left( \frac{E_a + E_b}{100} \right)}$

especially at  $D_x \leq 0.1$   $\pm \frac{E_a + E_b}{100}$

Q:  
at  $\left| Q_x \tan \left( \frac{E_a + E_b}{100} \right) \right| < 1$   $\pm \frac{(1 + Q_x^2) \tan \left( \frac{E_a + E_b}{100} \right)}{1 \mp Q_x \tan \left( \frac{E_a + E_b}{100} \right)}$

especially at  $\frac{10}{E_a + E_b} \geq Q_x \geq 10$   $\pm Q_x^2 \frac{E_a + E_b}{100}$

1. If the calibration is performed in 5 °C to 18 °C or 28 °C to 40 °C, the accuracy is degraded to doubled value (typical).
2. If the calibration is performed in different frequency points or different DC bias points from the measurement, the accuracy is degraded to doubled value (typical).

## Measurement Accuracy (Continued)

Accuracy when open/short/load/low-loss capacitor calibration is performed (typical)

Condition:

Point average factor  $\geq 32$

$-23 \text{ dBm} \leq \text{oscillator level} \leq +1 \text{ dBm}$

Calibration points are same as measurement points

(User frequency mode)

Measurement is performed within  $\pm 1 \text{ }^\circ\text{C}$  from the calibration temperature

$$|Z|, |Y|: \quad \pm(E_a + E_b) [\%]$$

$$\theta: \quad \pm \frac{E_c}{100} [\text{rad}]$$

$$L, C, X, B: \quad \pm \sqrt{(E_a + E_b)^2 + (E_c D_x)^2} [\%]$$

$$R, G: \quad \pm \sqrt{(E_a + E_b)^2 + (E_c Q_x)^2} [\%]$$

$$D: \quad \text{at } \left| D_x \tan \left( \frac{E_c}{100} \right) \right| < 1 \quad \pm \frac{(1 + D_x^2) \tan \left( \frac{E_c}{100} \right)}{1 \mp D_x \tan \left( \frac{E_c}{100} \right)}$$

$$\text{especially at } D_x \leq 0.1 \quad \pm \frac{E_c}{100}$$

$$Q: \quad \text{at } \left| Q_x \tan \left( \frac{E_c}{100} \right) \right| < 1 \quad \pm \frac{(1 + Q_x^2) \tan \left( \frac{E_c}{100} \right)}{1 \mp Q_x \tan \left( \frac{E_c}{100} \right)}$$

$$\text{especially at } \frac{10}{E_c} \geq Q_x \geq 10 \quad \pm Q_x^2 \frac{E_c}{100}$$

### Definition of each parameter

$D_x$  = Measurement value of D

$Q_x$  = Measurement value of Q

$E_a$  = (Within  $\pm 5 \text{ }^\circ\text{C}$  from the calibration temperature. Measurement accuracy applies when the calibration is performed at  $23 \text{ }^\circ\text{C} \pm 5 \text{ }^\circ\text{C}$ . When the calibration is performed beyond  $23 \text{ }^\circ\text{C} \pm 5 \text{ }^\circ\text{C}$ , measurement error doubles.)

at  $-23 \text{ dBm} \leq \text{oscillator level} \leq 1 \text{ dBm}$ :

0.60 [%] (1 MHz  $\leq$  Frequency  $\leq$  100 MHz)

0.70 [%] (100 MHz  $<$  Frequency  $\leq$  500 MHz)

1.00 [%] (500 MHz  $<$  Frequency  $\leq$  1 GHz)

2.00 [%] (1 GHz  $<$  Frequency  $\leq$  1.8 GHz)

4.00 [%] (1.8 GHz  $<$  Frequency  $\leq$  3 GHz)

at  $-33 \text{ dBm} \leq \text{oscillator level} < -23 \text{ dBm}$ :

0.65 [%] (1 MHz  $\leq$  Frequency  $\leq$  100 MHz)

0.75 [%] (100 MHz  $<$  Frequency  $\leq$  500 MHz)

1.05 [%] (500 MHz  $<$  Frequency  $\leq$  1 GHz)

2.05 [%] (1 GHz  $<$  Frequency  $\leq$  1.8 GHz)

4.05 [%] (1.8 GHz  $<$  Frequency  $\leq$  3 GHz)

## Measurement Accuracy (Continued)

at  $-40 \text{ dBm} \leq \text{oscillator level} < -33 \text{ dBm}$ :

0.80 [%] ( $1 \text{ MHz} \leq \text{Frequency} \leq 100 \text{ MHz}$ )

0.90 [%] ( $100 \text{ MHz} < \text{Frequency} \leq 500 \text{ MHz}$ )

1.20 [%] ( $500 \text{ MHz} < \text{Frequency} \leq 1 \text{ GHz}$ )

2.20 [%] ( $1 \text{ GHz} < \text{Frequency} \leq 1.8 \text{ GHz}$ )

4.20 [%] ( $1.8 \text{ GHz} < \text{Frequency} \leq 3 \text{ GHz}$ )

$$E_b = \left[ \frac{Z_s}{|Z_x|} + Y_o \{Z_x\} \right] \times 100 \text{ [%]}$$

( $|Z_x|$ : measurement value of  $|Z|$ )

$E_c =$  (see below) [%]

at  $1 \text{ MHz} \leq \text{frequency} \leq 10 \text{ MHz}$

$$\left[ 0.03 + \frac{0.08 \times F}{1000} + \frac{0.03}{|Z_x|} \right] \text{ [%] at } |Z_x| < 1 \Omega$$

$$\left[ 0.06 + \frac{0.08 \times F}{1000} \right] \text{ [%] at } 1 \Omega \leq |Z_x| \leq 1.8 \text{ k}\Omega$$

$$\left[ 0.03 + \frac{0.08 \times F}{1000} + \frac{|Z_x|}{60000} \right] \text{ [%] at } |Z_x| > 1.8 \text{ k}\Omega$$

at  $10 \text{ MHz} < \text{frequency} < 100 \text{ MHz}$

$$\left[ 0.05 + \frac{0.08 \times F}{1000} + \frac{0.03}{|Z_x|} \right] \text{ [%] at } |Z_x| < 3 \Omega$$

$$\left[ 0.06 + \frac{0.08 \times F}{1000} \right] \text{ [%] at } 3 \Omega \leq |Z_x| \leq 600 \Omega$$

$$\left[ 0.05 + \frac{0.08 \times F}{1000} + \frac{|Z_x|}{60000} \right] \text{ [%] at } |Z_x| > 600 \Omega$$

at  $100 \text{ MHz} \leq \text{frequency} \leq 3 \text{ GHz}$

$$\left[ 0.03 + \frac{0.08 \times F}{1000} + \frac{0.03}{|Z_x|} \right] \text{ [%] at } |Z_x| < 1 \Omega$$

$$\left[ 0.06 + \frac{0.08 \times F}{1000} \right] \text{ [%] at } 1 \Omega \leq |Z_x| \leq 1.8 \text{ k}\Omega$$

$$\left[ 0.03 + \frac{0.08 \times F}{1000} + \frac{|Z_x|}{60000} \right] \text{ [%] at } |Z_x| > 1.8 \text{ k}\Omega$$

(F: frequency [MHz], typical)

$Z_s =$  (Specification values of “point averaging factor  $\geq 8$ ” is applied only when point averaging factors at both calibration and measurement are 8 or greater.)

at oscillator level =  $-3 \text{ dBm}$  or  $-13 \text{ dBm}$ :

$(11 + 0.5 \times F)$  [m $\Omega$ ] (averaging factor  $\geq 8$ )

$(12 + 0.5 \times F)$  [m $\Omega$ ] (averaging factor  $\leq 7$ )

at oscillator level =  $-23 \text{ dBm}$ :

$(12 + 0.5 \times F)$  [m $\Omega$ ] (averaging factor  $\geq 8$ )

$(16 + 0.5 \times F)$  [m $\Omega$ ] (averaging factor  $\leq 7$ )

## Measurement Accuracy (Continued)

At  $-23 \text{ dBm} < \text{oscillator level} \leq 1 \text{ dBm}$ :

- $(17 + 0.5 \times F) \text{ [m}\Omega\text{]}$  (averaging factor  $\geq 8$ )
- $(21 + 0.5 \times F) \text{ [m}\Omega\text{]}$  (averaging factor  $\leq 7$ )

At  $-33 \text{ dBm} \leq \text{oscillator level} < -23 \text{ dBm}$ :

- $(25 + 0.5 \times F) \text{ [m}\Omega\text{]}$  (averaging factor  $\geq 8$ )
- $(50 + 0.5 \times F) \text{ [m}\Omega\text{]}$  (averaging factor  $\leq 7$ )

At  $-40 \text{ dBm} \leq \text{oscillator level} < -33 \text{ dBm}$ :

- $(50 + 0.5 \times F) \text{ [m}\Omega\text{]}$  (averaging factor  $\geq 8$ )
- $(10 + 0.5 \times F) \text{ [m}\Omega\text{]}$  (averaging factor  $\leq 7$ )

$Y_0$  = (Specification values of “point averaging factor  $\geq 8$ ” is applied only when point averaging factors at both calibration and measurement are 8 or greater.)

At  $-17 \text{ dBm} \leq \text{oscillator level} \leq 1 \text{ dBm}$ :

- $(1.7 + 0.1 \times F) \text{ [}\mu\text{S]}$  (averaging factor  $\geq 8$ )
- $(4.0 + 0.1 \times F) \text{ [}\mu\text{S]}$  (averaging factor  $\leq 7$ )

At  $-23 \text{ dBm} \leq \text{oscillator level} < -17 \text{ dBm}$ :

- $(4.0 + 0.1 \times F) \text{ [}\mu\text{S]}$  (averaging factor  $\geq 8$ )
- $(8.0 + 0.1 \times F) \text{ [}\mu\text{S]}$  (averaging factor  $\leq 7$ )

At  $-33 \text{ dBm} \leq \text{oscillator level} < -23 \text{ dBm}$ :

- $(10.0 + 0.1 \times F) \text{ [}\mu\text{S]}$  (averaging factor  $\geq 8$ )
- $(30.0 + 0.1 \times F) \text{ [}\mu\text{S]}$  (averaging factor  $\leq 7$ )

At  $-40 \text{ dBm} \leq \text{oscillator level} < -33 \text{ dBm}$ :

- $(20.0 + 0.1 \times F) \text{ [}\mu\text{S]}$  (averaging factor  $\geq 8$ )
- $(60.0 + 0.1 \times F) \text{ [}\mu\text{S]}$  (averaging factor  $\leq 7$ )

## Calculated impedance measurement accuracy

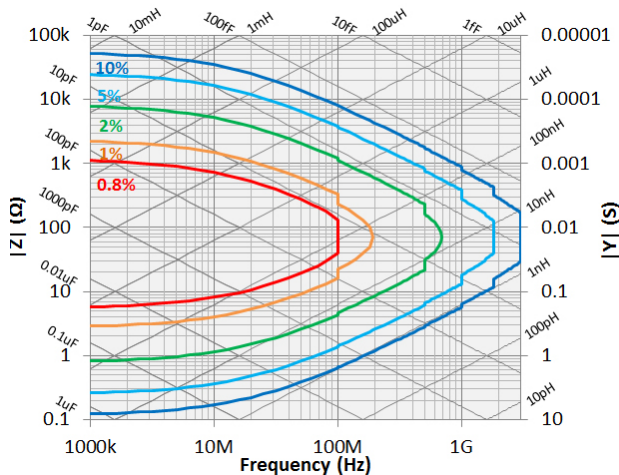

Figure 1.  $|Z|$ ,  $|Y|$  Measurement accuracy when open/short/load calibration is performed. Oscillator level =  $-13 \text{ dBm}$ ,  $-3 \text{ dBm}$ . Point averaging factor  $\geq 8$  within  $\pm 5 \text{ }^\circ\text{C}$  from the calibration temperature.

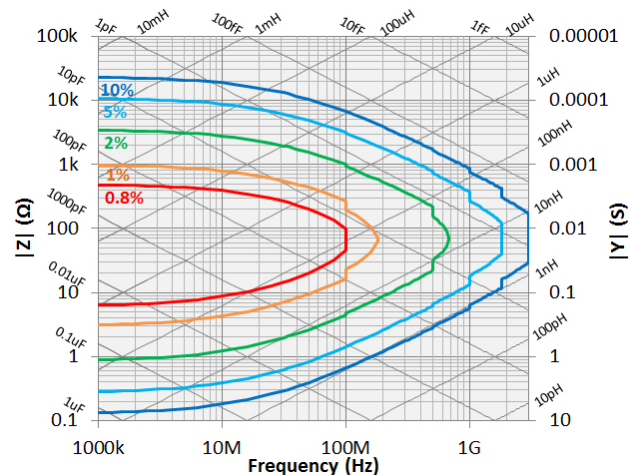

Figure 2.  $|Z|$ ,  $|Y|$  Measurement accuracy when open/short/load calibration is performed. Oscillator level  $-13 \text{ dBm}$ ,  $-3 \text{ dBm}$ . Point averaging factor  $\leq 7$  within  $\pm 5 \text{ }^\circ\text{C}$  from the calibration temperature.

## Calculated Impedance Measurement Accuracy (Continued)

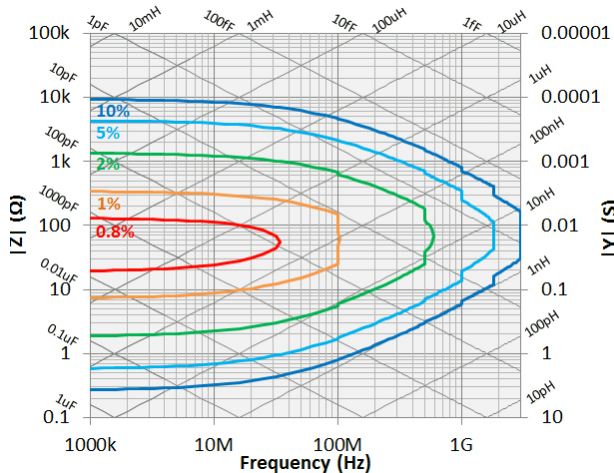

Figure 3.  $|Z|$ ,  $|Y|$  Measurement accuracy when open/short/load calibration is performed. Oscillator level =  $-33$  dBm. Point averaging factor  $\geq 8$  within  $\pm 5$  °C from the calibration temperature.

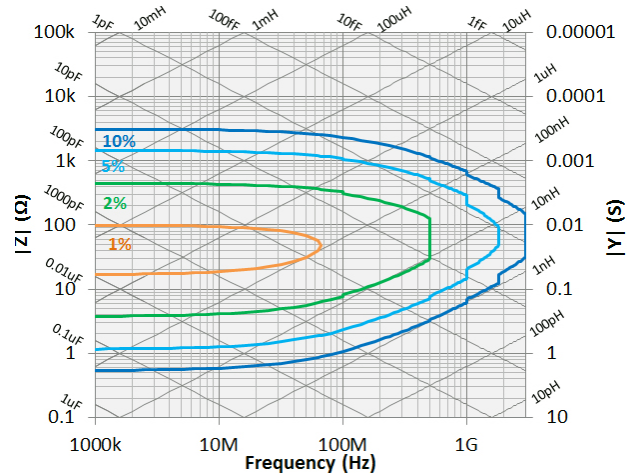

Figure 4.  $|Z|$ ,  $|Y|$  Measurement accuracy when open/short/load calibration is performed. Oscillator level =  $-33$  dBm. Point averaging factor  $\leq 7$  within  $\pm 5$  °C from the calibration temperature.

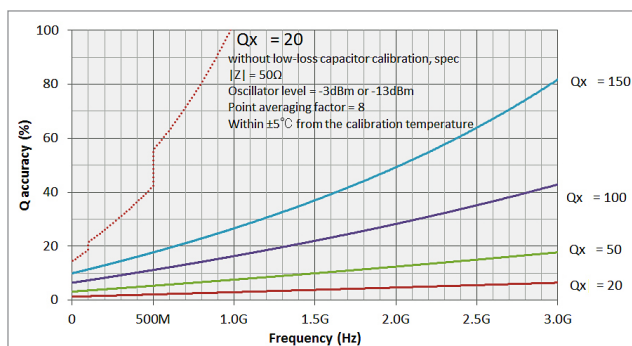

Figure 5. Q accuracy without low-loss capacitor calibration (Specification) and with low-loss capacitor calibration (Typical).

## Measurement Support Functions

### Error correction

#### Available calibration and compensation

##### Open/short/load calibration:

- Connect open, short, and load standards to the desired reference plane and measure each kind of calibration data. The reference plane is called the calibration reference plane.

##### Low-loss capacitor calibration:

- Connect the dedicated standard (low-loss capacitor) to the calibration reference plane and measure the calibration data.

##### Port extension compensation (fixture selection):

- When a device is connected to a terminal that is extended from the calibration reference plane, set the electrical length between the calibration plane and the device contact. Select the model number of the registered test fixtures in the E4991B's setup toolbar or enter the electrical length for the user's test fixture.

## Measurement Support Functions (Continued)

Open/short compensation:

- When a device is connected to a terminal that is extended from the calibration reference plane, make open and/or short states at the device contact and measure each kind of compensation data.

### Calibration/compensation data measurement point

Fixed frequency mode:

- Obtain calibration/compensation data at fixed frequency covering the entire frequency range of the E4991B. In device measurement, calibration or compensation is applied to each measurement point by using interpolation. Even if the measurement points are changed by altering the sweep setups, you don't need to retake the calibration/compensation data.

User-defined frequency mode:

- Obtain calibration/compensation data at the same frequency as used in actual device measurement, which are determined by the sweep setups. Each set of calibration/compensation data is applied to each measurement at the same frequency point. If the measurement points are changed by altering the sweep setups, calibration/compensation data become invalid and retaking calibration/compensation data is recommended.

## Trigger

Trigger mode:

- Internal, external (external trigger input connector), bus (GPIB/LAN/USB), manual (front key)

## Averaging

Types:

- Sweep-to-sweep averaging, point averaging

Setting range:

- Sweep-to-sweep averaging: 1 to 999 (integer)
- Point averaging: 1 to 999 (integer)

## Display

LCD display:

- Type/size: 10.4 inch TFT color LCD
- Resolution: XGA (1024 x 768) <sup>1</sup>

Number of traces:

- Data trace: 4 data traces per channel (maximum)
- Memory trace: 4 memory traces per channel (maximum)

Trace data math:

- Data + Memory, Data - Memory, Data x Memory, Data/ Memory, Offset, Equation Editor

Format:

- For scalar parameters: linear Y-axis, log Y-axis
- For complex parameters: Z, Y,  $\epsilon_r$ ,  $\mu_r$ : polar, complex;  $\Gamma$ : polar, complex, Smith, admittance

1. Valid pixels are 99.99% and more. Below 0.01% of fixed points of black, green, or red are not regarded as failure.

## Measurement Support Functions (Continued)

Other display functions:

Each measurement channel has a display window with independent stimulus. Up to 4 display windows (channels) can be displayed.

### Marker

Number of markers:

10 independent markers per trace. Reference marker available for delta marker operation

Marker search:

Search type: max value, min value, multi-peak, multi-target, peak, peak left, peak right, target, target left, target right, and width parameters with userdefined bandwidth values

Search track: Performs search by each sweep

Search range: User definable

Other functions:

Marker continuous mode,  $\Delta$  marker mode, Marker coupled mode, Marker value substitution (Marker&), Marker zooming, Marker list, Marker statistics, and Marker signal/dc bias monitor

### Equivalent circuit analysis

Circuit models:

3-component model (4 models)

4-component model (3 models)

Analysis types:

Equivalent circuit parameters calculation, frequency characteristics simulation

### Limit line test

Define the test limit lines that appear on the display for define the test limit lines that appear on the display for pass/fail testing. Defined limits may be any combination of horizontal/sloping lines and discrete data points. testing. Defined limits may be any combination of horizontal/sloping lines and discrete data points.

## Interface

### GPIB

24-pin D-Sub (Type D-24), female; compatible with IEEE-488.

IEEE-488 interface specification is designed to be used in environment where electrical noise is relatively low. LAN or USBTMC interface is recommended to use at the higher electrical noise environment.

### LAN interface

10/100/1000 Base T Ethernet, 8-pin configuration; auto selects between the two data rates

1. Refer to the standard for the meaning of each function code.

## Interface (Continued)

### USB host port

Universal serial bus jack, Type A configuration; female; provides connection to mouse, keyboard, printer or USB stick memory.

### USB (USBTMC ) interface port

Universal serial bus jack, Type B configuration (4 contacts inline); female; provides connection to an external PC; compatible with USBTMC-USB488 and USB 2.0.LA USB Test and Measurement Class (TMC) interface that communicates over USB, complying with the IEEE 488.1 and IEEE 488.2 standards.

### Handler interface

36-pin centronics, female

## Measurement Terminal (At Test Head)

Connector type: 7-mm connector

## Rear Panel Connectors

### External reference signal input connector

Frequency: 10 MHz  $\pm$  10 ppm (typical)

Level: 0 dBm  $\pm$  3 dB (typical)

Input impedance: 50  $\Omega$  (nominal)

Connector type: BNC, female

### Internal reference signal output connector

Frequency: 10 MHz  $\pm$  10 ppm (typical)

Level: 0 dBm  $\pm$  3 dB into 50  $\Omega$  (typical)

Output impedance: 50  $\Omega$  (nominal)

Connector type: BNC, female

### High stability frequency reference output connector (Option E4991B-1E5)

Frequency: 10 MHz  $\pm$  1 ppm

Level: 0 dBm minimum

Output impedance: 50  $\Omega$  (nominal)

Connector type: BNC, female

### External trigger input connector

Level:

LOW threshold voltage: 0.5 V

HIGH threshold voltage: 2.1 V

Input level range: 0 V to +5 V



## Rear Panel Connectors (Continued)

Pulse width ( $T_p$ ):

$\geq 2 \mu\text{sec}$  (typical). See Figure 6 for definition of  $T_p$ .

Polarity: Positive or negative (selective)

Connector type: BNC, female

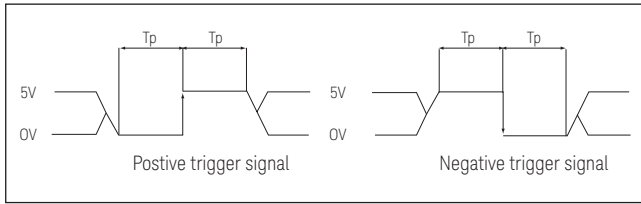

Figure 6. Definition of pulse width ( $T_p$ ).

## General Characteristics

### Environment conditions

#### Operating condition

Temperature: 5 °C to 40 °C

Humidity:

20% to 80% at wet bulb temperature  $< +29$  °C (non-condensation))

Altitude: 0 m to 2,000 m (0 feet to 6,561 feet)

Vibration: 0.21 Grms maximum, 5 Hz to 500 Hz

Warm-up time: 30 minutes

#### Non-operating storage condition

Temperature: -10 °C to +60 °C

Humidity:





20% to 90% at wet bulb temperature  $< +40$  °C (non-condensation))

Altitude: 0 m to 4,572 m (0 feet to 15,000 feet)

Vibration: 2.1 Grms maximum, 5 Hz to 500 Hz

## General Characteristics (Continued)

### EMC, safety, environment and compliance

Description	General characteristics
<b>EMC</b>   ISM 1-A	European Council Directive 2004/108/EC IEC 61326-1:2012 EN 61326-1:2013 CISPR 11:2009 +A1:2010 EN 55011: 2009 +A1:2010 Group 1, Class A IEC 61000-4-2:2008 EN 61000-4-2:2009 4 kV CD / 8 kV AD IEC 61000-4-3:2006 +A1:2007 +A2:2010 EN 61000-4-3:2006 +A1:2008 +A2:2010 3 V/m, 80-1000 MHz, 1.4 to 2.0 GHz / 1V/m, 2.0 to 2.7 GHz, 80% AM IEC 61000-4-4:2004 +A1:2010 EN 61000-4-4:2004 +A1:2010 1 kV power lines / 0.5 kV signal lines IEC 61000-4-5:2005 EN 61000-4-5:2006 0.5 kV line-line / 1 kV line-ground IEC 61000-4-6:2008 EN 61000-4-6:2009 3 V, 0.15-80 MHz, 80% AM IEC 61000-4-8:2009 EN 61000-4-8:2010 30A/m, 50/60Hz IEC 61000-4-11:2004 EN 61000-4-11:2004 0.5-300 cycle, 0% / 70%
	NOTE-1: When tested at 3 V/m according to EN61000-4-3, the measurement accuracy will be within specifications over the full immunity test frequency range except when the analyzer frequency is identical to the transmitted interference signal test frequency.  NOTE-2: When tested at 3 V according to EN61000-4-6, the measurement accuracy will be within specifications over the full immunity test frequency range except when the analyzer frequency is identical to the transmitted interference signal test frequency.
ICES/NMB-001	ICES-001:2006 Group 1, Class A
	AS/NZS CISPR11:2004 Group 1, Class A
	KN11, KN61000-6-1 and KN61000-6-2 Group 1, Class A
<b>Safety</b>	
 ISM 1-A	European Council Directive 2006/95/EC IEC 61010-1:2010 / EN 61010-1:2010 Measurement Category I Pollution Degree 2 Indoor Use

## EMC, safety, environment and compliance (Continued)



CAN/CSA C22.2 No. 61010-1-12  
 Measurement Category I  
 Pollution Degree 2  
 Indoor Use

### Environment



This product complies with the WEEE Directive (2002/96/EC) marking requirements. The affixed label indicates that you must not discard this electrical/electronic product in domestic household waste.

To return unwanted products, contact your local Keysight office, or see (<http://www.keysight.com/environment/product/>) for more information.

Product Category: With reference to the equipment types in the WEEE Directive Annex I, this product is classed as a “Monitoring and Control instrumentation” product. Do not dispose in domestic household waste.

### Compliance



Class C

### Power requirements

90V to 264V AC (Vpeak > 120V), 47 Hz to 63 Hz, 300 VA maximum

### Weight

Main unit: 13 kg  
 Test head: 1 kg

### Dimensions

Main unit: See Figure 7 through Figure 9

Test head: See Figure 10

Option 007 test head dimensions: See Figure 11

Option 010 test head dimensions: See Figure 12

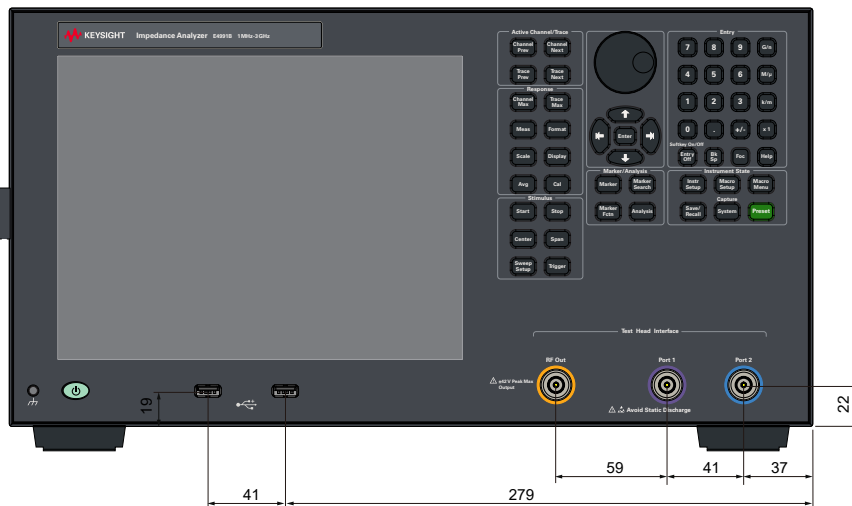

Figure 7. Main unit dimensions (front view, in millimeters).

## General Characteristics (Continued)

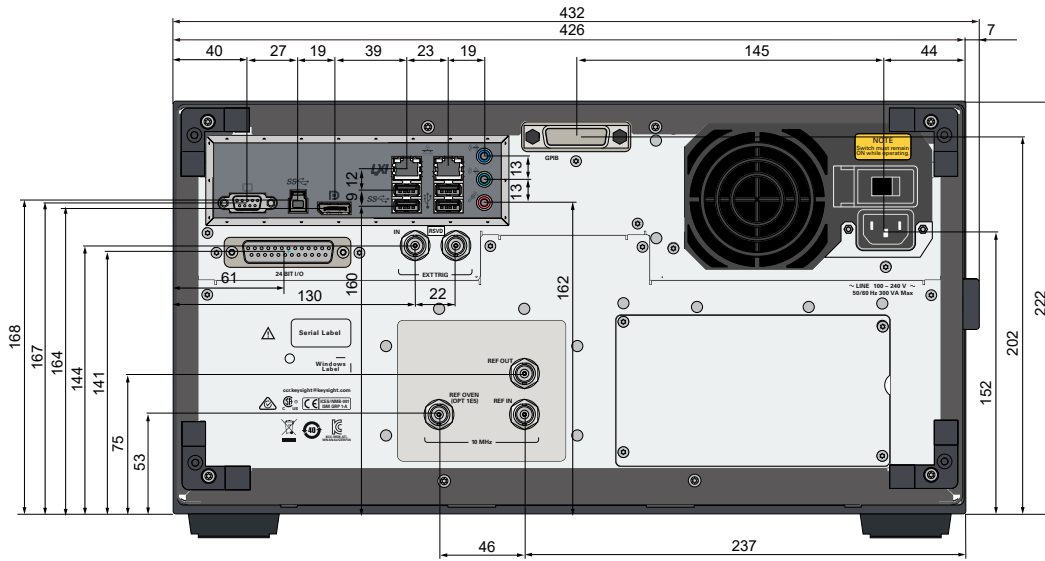

Figure 8. Main unit dimensions (rear view, in millimeters).

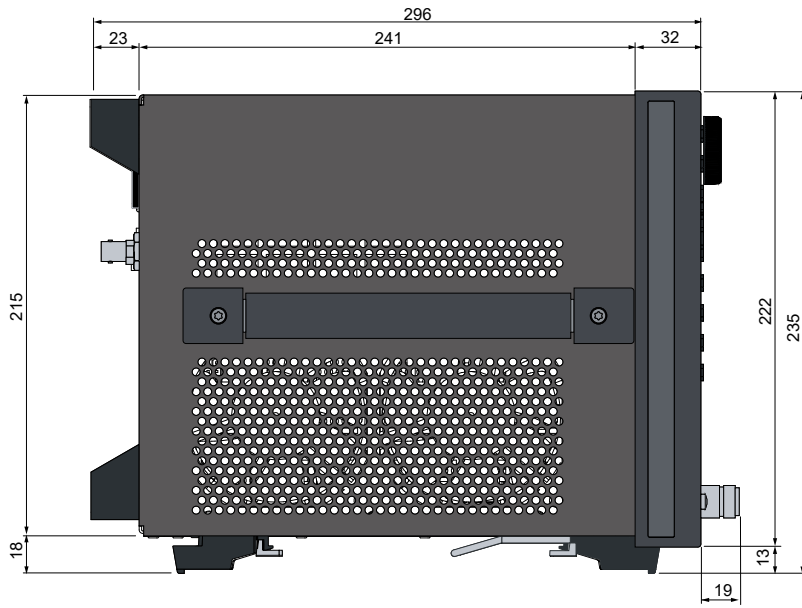

Figure 9. Main unit dimensions (side view, in millimeters).

## General Characteristics (Continued)

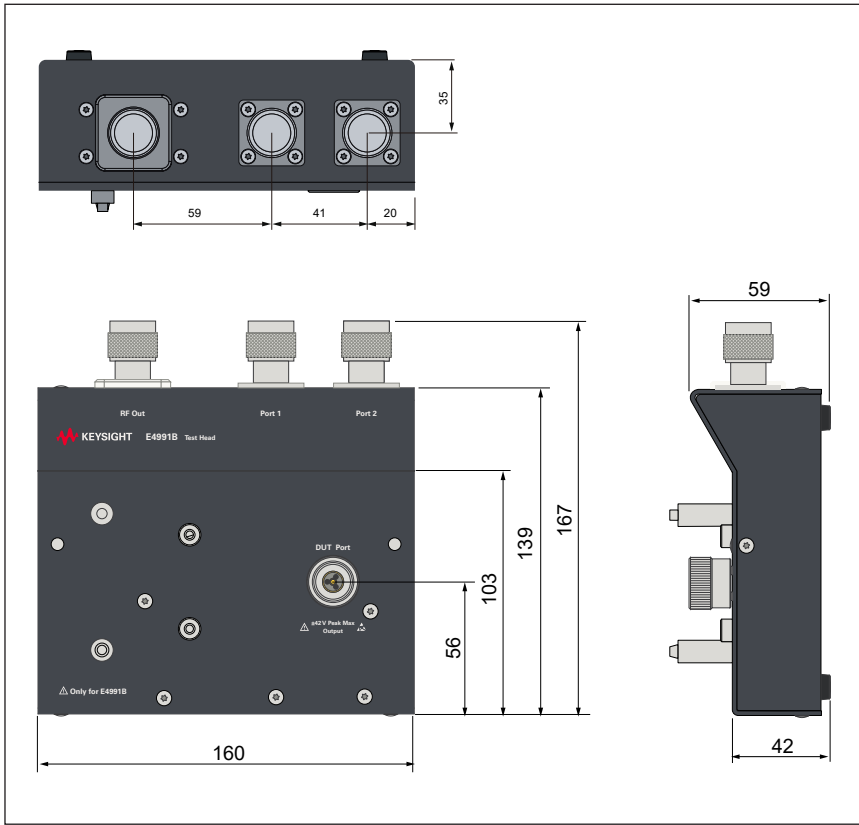

Figure 10. Test head dimensions (in millimeters).

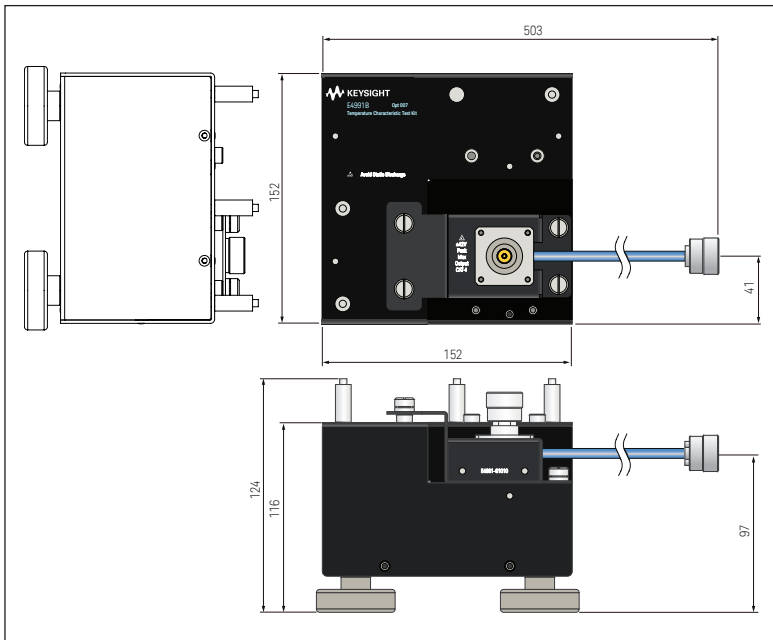

Figure 11. Option E4991B-007 test head dimensions (in millimeters).

## General Characteristics (Continued)

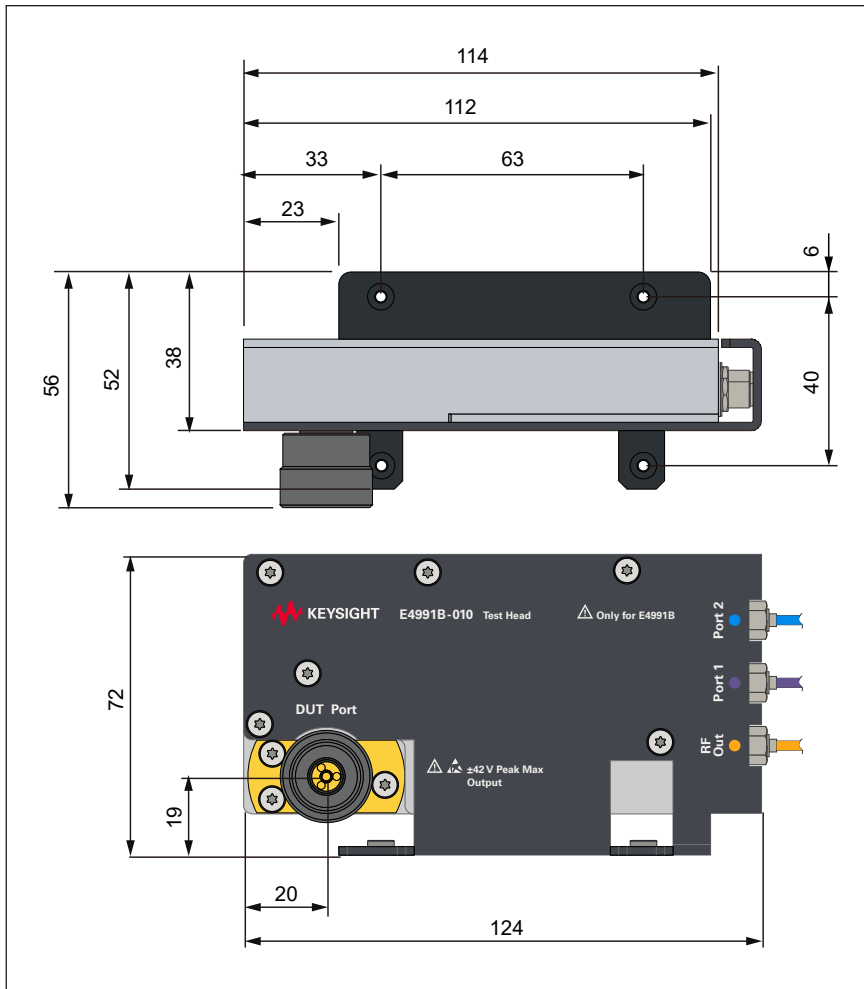

Figure 12. Option E4991B-010 test head dimensions (in millimeters).

# Option E4991B-002 Material Measurement (Typical)

## Measurement parameter

Permittivity parameters:  $|\epsilon_r|$ ,  $\epsilon_r'$ ,  $\epsilon_r''$ ,  $\tan\delta$

Permeability parameters:  $|\mu_r|$ ,  $\mu_r'$ ,  $\mu_r''$ ,  $\tan\delta$

## Frequency range

Using with Keysight 16453A: 1 MHz to 1 GHz (typical)

Using with Keysight 16454A: 1 MHz to 1 GHz (typical)

## Measurement accuracy

Conditions for defining accuracy:

Calibration:

- Open, short, and load calibration at electrodes of 16453A when using the 16453A
- Open, short, and load calibration at test port (7-mm connector) of the test head, then Short compensation at 16454A when using the 16454A

Calibration temperature:

- Calibration is performed at an environmental temperature within the range of  $23\text{ °C} \pm 5\text{ °C}$ .
- Measurement accuracy doubles when calibration temperature is  $5\text{ °C}$  to  $18\text{ °C}$  or  $28\text{ °C}$  to  $40\text{ °C}$ .

Temperature:

- Temperature deviation: within  $\pm 5\text{ °C}$  from the calibration temperature
- Environment temperature: Measurement accuracy applies when the calibration is performed at  $23\text{ °C} \pm 5\text{ °C}$ . When the calibration is below  $18\text{ °C}$  or above  $28\text{ °C}$ , measurement error doubles.

Measurement frequency points:

- Same as calibration points<sup>1</sup>
- Point averaging factor:  $\geq 8$
- Electrode pressure setting of 16453A: maximum

Typical accuracy of permittivity parameters:

$$\epsilon_r' \text{ accuracy} \quad \left( = \frac{\Delta\epsilon_{r m}'}{\epsilon_{r m}'} \right):$$
$$\pm \left[ 5 + \left( 10 + \frac{0.1}{f} \right) \frac{t}{\epsilon_{r m}'} + 0.25 \frac{\epsilon_{r m}'}{t} + \frac{100}{\left| 1 - \left( \frac{13}{f \sqrt{\epsilon_{r m}'}} \right)^2 \right|} \right] [\%]$$

(at  $\tan\delta < 0.1$ )

Loss tangent accuracy of  $\epsilon_r'$  ( $= \Delta\tan\delta$ ):

$$\pm (E_a + E_b) \text{ (at } \tan\delta < 0.1)$$

where,

$$E_a =$$

at Frequency  $\leq 1\text{ GHz}$ :

$$0.002 + \frac{0.001}{f} \cdot \frac{t}{\epsilon_{r m}'} + 0.004f + \frac{0.1}{\left| 1 - \left( \frac{13}{f \sqrt{\epsilon_{r m}'}} \right)^2 \right|}$$

1. In fixed frequency calibration mode, if a measurement frequency point is not included in the calibration points, the accuracy at the measurement point is degraded to its doubled value (typical).

## Option E4991B-002 Material Measurement (Typical) (Continued)

$$E_b = \left[ \frac{\Delta \epsilon'_{r,m}}{\epsilon'_{r,m}} \cdot \frac{1}{100} + \epsilon'_{r,m} \frac{0.002}{t} \right] \tan \delta$$

$f$  = Measurement frequency [GHz]

$t$  = Thickness of MUT (material under test) [mm]

$\epsilon'_{r,m}$  = Measured value of  $\epsilon'_r$

$\tan \delta$  = Measured value of dielectric loss tangent

Typical accuracy of permeability parameters:

$$\mu'_r \text{ accuracy} \left( = \frac{\Delta \mu'_{r,m}}{\mu'_{r,m}} \right):$$

$$4 + \frac{0.02}{f} \times \frac{25}{F \mu'_{r,m}} + F \mu'_{r,m} \left[ 1 + \frac{15}{F \mu'_{r,m}} \right]^2 f^2 [\%]$$

(at  $\tan \delta < 0.1$ )

Loss tangent accuracy of  $\mu_r$  ( $= \Delta \tan \delta$ ):

$$\pm (E_a + E_b) \text{ (at } \tan \delta < 0.1)$$

where,

$$E_a = \frac{0.002 + \frac{0.001}{F \mu'_{r,m} f} + 0.004f}{F \mu'_{r,m} f}$$

$$E_b = \frac{\Delta \mu'_{r,m}}{\mu'_{r,m}} \cdot \frac{\tan \delta}{100}$$

$f$  = Measurement frequency [GHz]

$$F = \frac{h \ln \frac{c}{b}}{b} \text{ [mm]}$$

$h$  = Height of MUT (material under test) [mm]

$b$  = Inner diameter of MUT (material under test) [mm]

$c$  = Outer diameter of MUT (material under test) [mm]

$\mu'_{r,m}$  = Measured value of  $\mu'_r$

$\tan \delta$  = Measured value of loss tangent



# Option E4991B-002 Material Measurement (Typical) (Continued)

Examples of calculated permittivity measurement accuracy

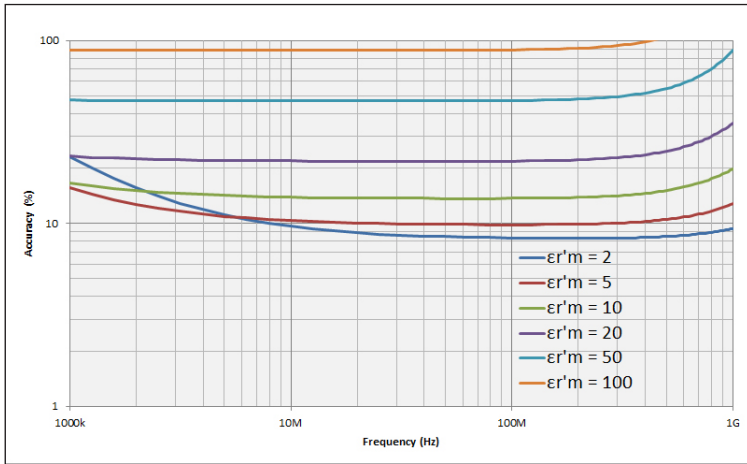

Figure 13. Permittivity accuracy ( $\frac{\Delta\epsilon'_r}{\epsilon'_r}$ ) vs. frequency (at  $t = 0.3$  mm, typical).

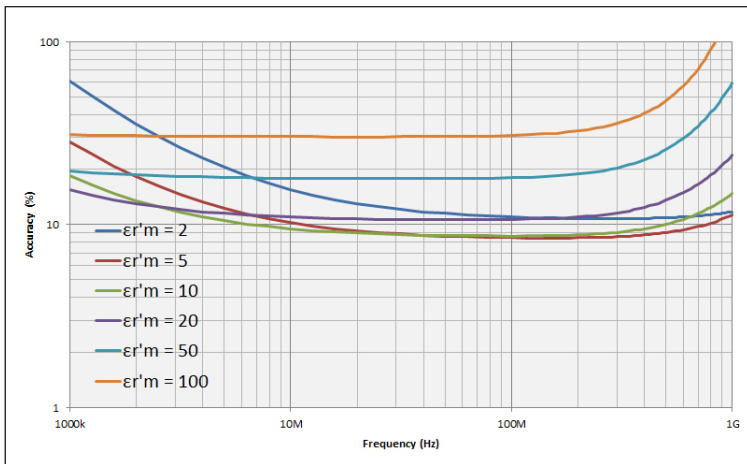

Figure 14. Permittivity accuracy ( $\frac{\Delta\epsilon'_r}{\epsilon'_r}$ ) vs. frequency (at  $t = 1$  mm, typical).

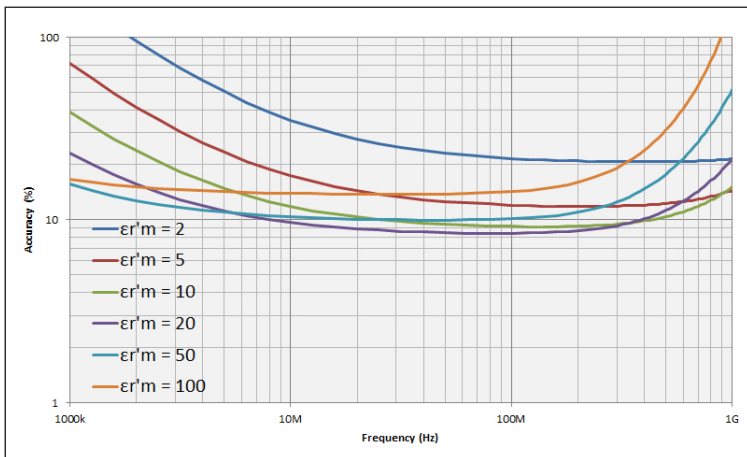

Figure 15. Permittivity accuracy ( $\frac{\Delta\epsilon'_r}{\epsilon'_r}$ ) vs. frequency (at  $t = 3$  mm, typical).

# Option E4991B-002 Material Measurement (Typical) (Continued)

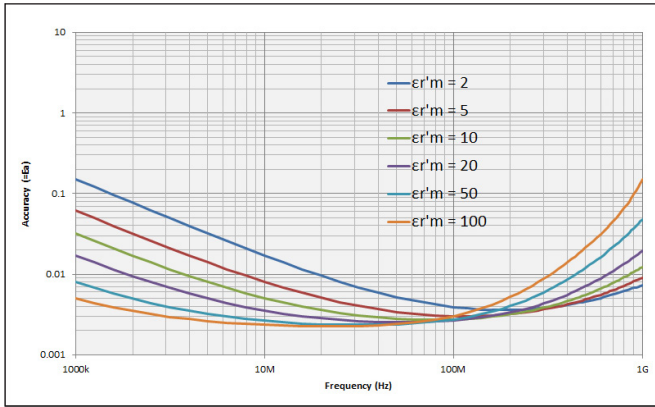

Figure 16. Dielectric loss tangent (tand) accuracy vs. frequency (at  $t = 0.3$  mm, typical)<sup>1</sup>

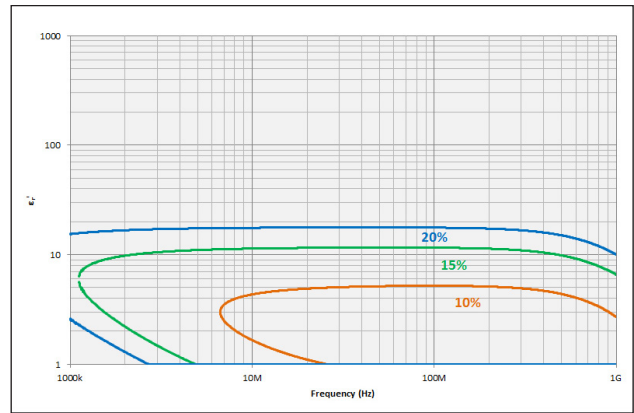

Figure 19. Permittivity ( $\epsilon_r$ ) vs. frequency (at  $t = 0.3$  mm, typical)

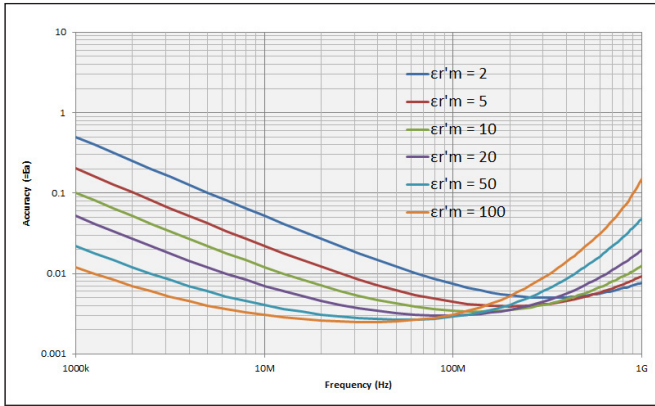

Figure 17. Dielectric loss tangent (tand) accuracy vs. frequency (at  $t = 1$  mm, typical)<sup>1</sup>

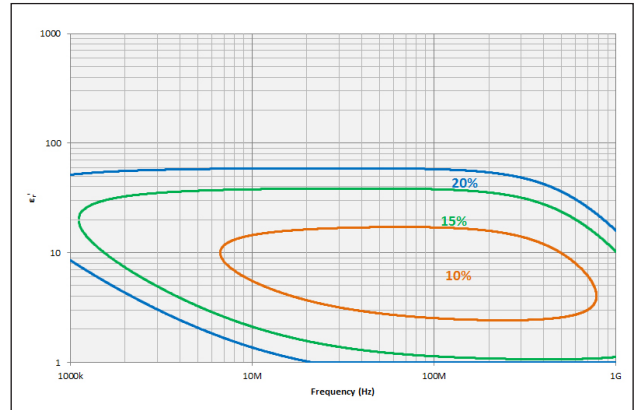

Figure 20. Permittivity ( $\epsilon_r$ ) vs. frequency (at  $t = 1$  mm, typical)

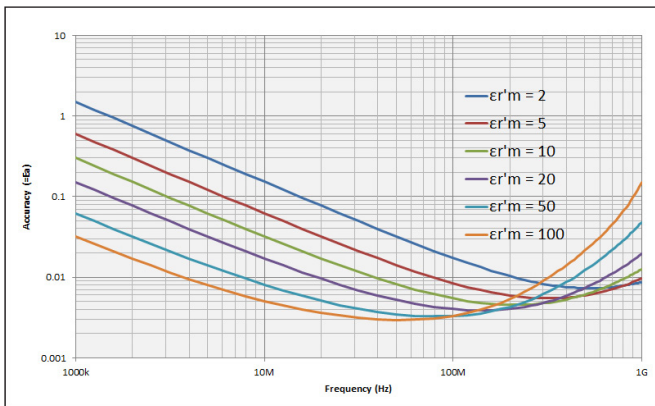

Figure 18. Dielectric loss tangent (tand) accuracy vs. frequency (at  $t = 3$  mm, typical)<sup>1</sup>

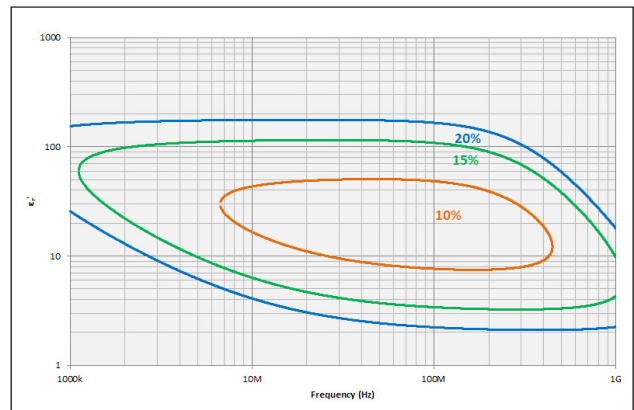

Figure 21. Permittivity ( $\epsilon_r$ ) vs. frequency (at  $t = 3$  mm, typical)

1. This graph shows only frequency dependence of  $E_a$  to simplify it. The typical accuracy of tand is defined as  $E_a + E_b$ ; refer to "Typical accuracy of permittivity parameters" on page 15.

# Option E4991B-002 Material Measurement (Typical) (Continued)

Examples of calculated permeability measurement accuracy

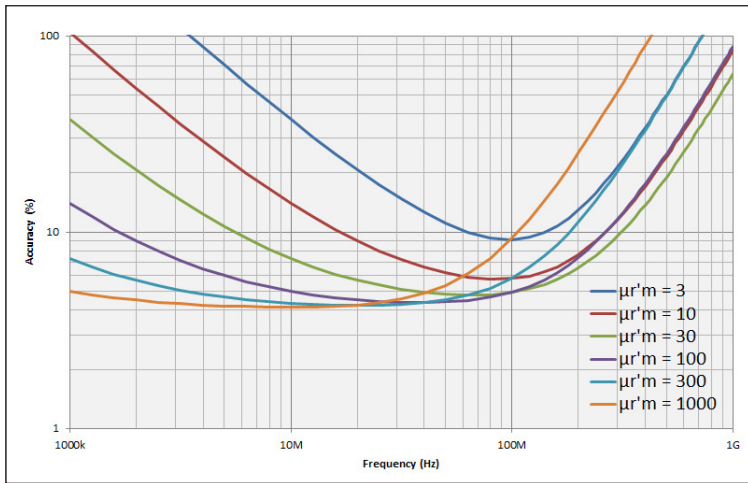

Figure 22. Permeability accuracy  $\left(\frac{\Delta\mu_r'}{\mu_r'}\right)$  vs. frequency (at  $F = 0.5$  mm, typical)

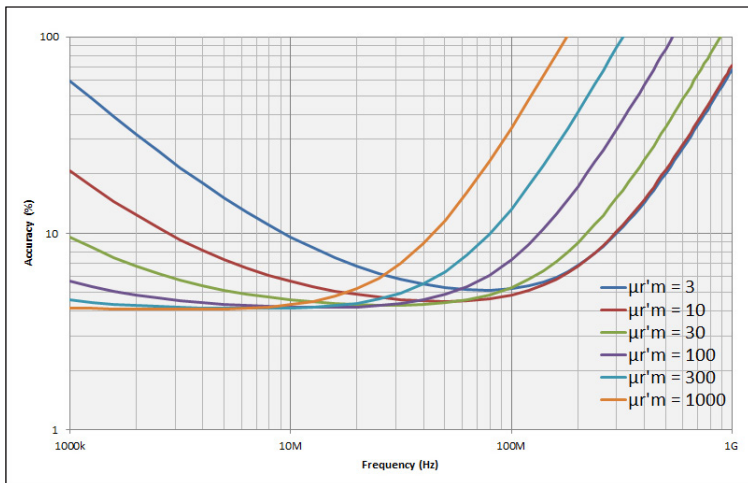

Figure 23. Permeability accuracy  $\left(\frac{\Delta\mu_r'}{\mu_r'}\right)$  vs. frequency (at  $F = 3$  mm, typical)

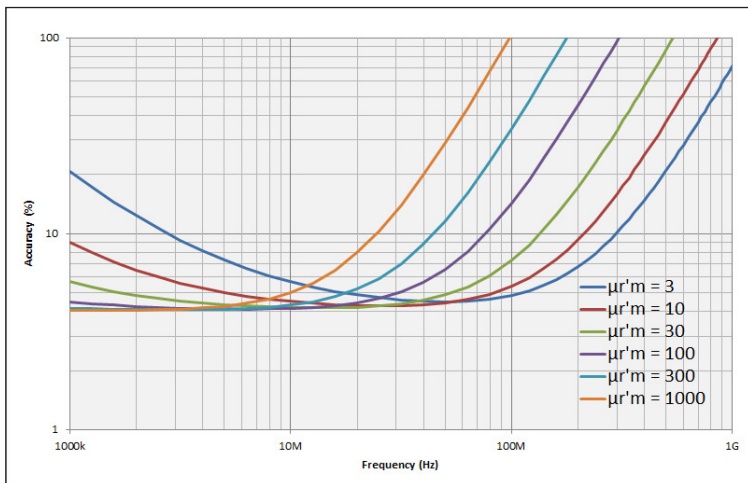

Figure 24. Permeability accuracy  $\left(\frac{\Delta\mu_r'}{\mu_r'}\right)$  vs. frequency (at  $F = 10$  mm, typical)

# Option E4991B-002 Material Measurement (Typical) (Continued)

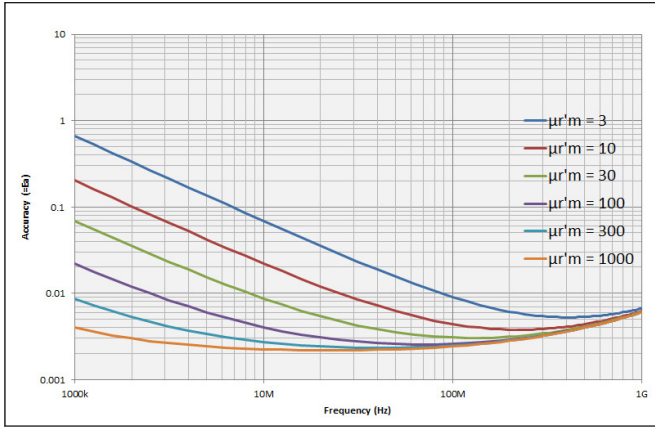

Figure 25. Permeability loss tangent ( $\tan\delta$ ) accuracy vs. frequency (at  $F = 0.5$  mm, typical) <sup>1</sup>

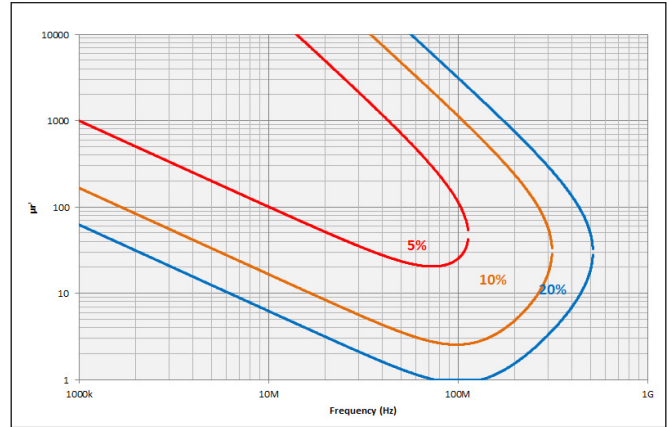

Figure 28. Permeability ( $\mu_p$ ) vs. frequency (at  $F = 0.5$  mm, typical)

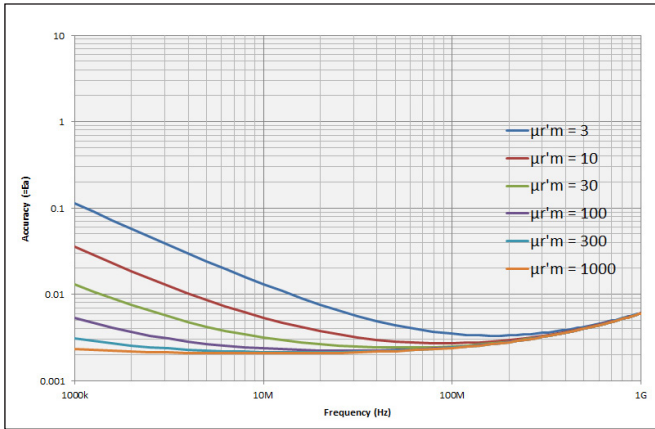

Figure 26. Permeability loss tangent ( $\tan\delta$ ) accuracy vs. frequency (at  $F = 3$  mm, typical) <sup>1</sup>

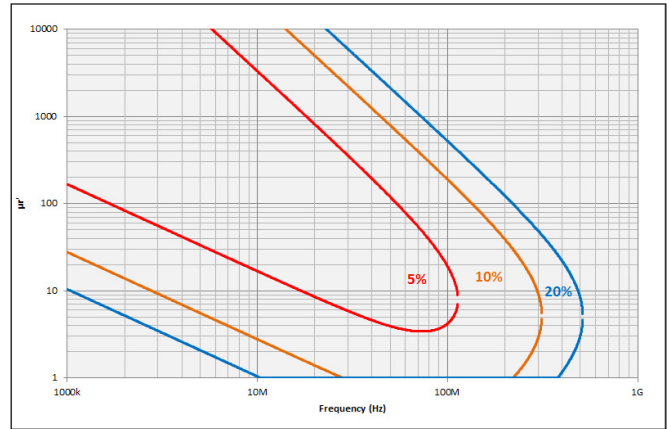

Figure 29. Permeability ( $\mu_p$ ) vs. frequency (at  $F = 3$  mm, typical)

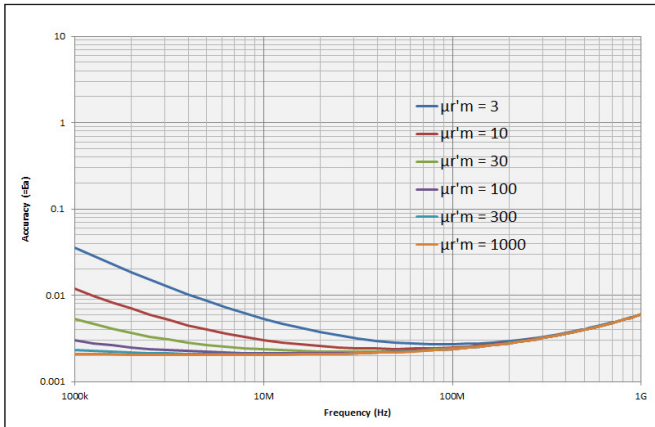

Figure 27. Permeability loss tangent ( $\tan\delta$ ) accuracy vs. frequency (at  $F = 10$  mm, typical) <sup>1</sup>

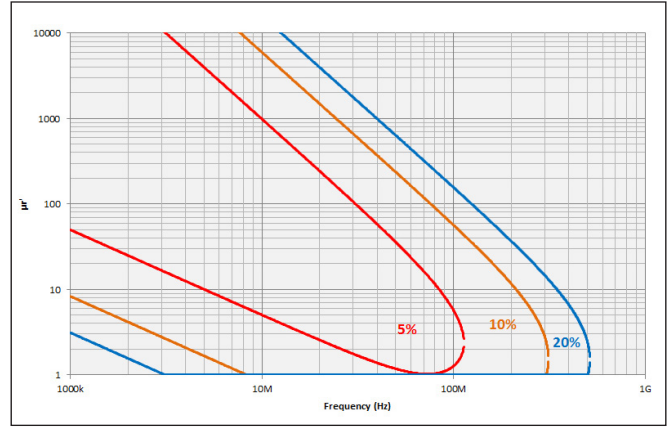

Figure 30. Permeability ( $\mu_p$ ) vs. frequency (at  $F = 10$  mm, typical)

1. This graph shows only frequency dependence of  $E_a$  to simplify it. The typical accuracy of  $\tan\delta$  is defined as  $E_a + E_b$ ; refer to "Typical accuracy of permeability parameters" on page 16.

# Option E4991B-007 Temperature Characteristic Test Kit

This section contains specifications and supplemental information for the E4991B Option E4991B-007. Except for the contents in this section, the E4991B standard specifications and supplemental information are applied.

## Operation temperature

Range:

–55 °C to +150 °C

(at the test port of the high temperature cable)

+5 °C to +40 °C

(Main unit, test head, and their connection cable)

## Source characteristics

### Frequency

Range:

1 MHz to 3 GHz (Option 300)

1 MHz to 1 GHz (Option 100)

1 MHz to 500 MHz (Option 050)

### Oscillator level

Source power accuracy at the test port of the high temperature cable:

Frequency  $\leq$  1 GHz:

Minimum: –4 dB, Maximum: +2 dB (23°C  $\pm$  5°C)

Minimum: –6 dB, Maximum: +4 dB (5 °C to 40 °C)

Frequency  $>$  1 GHz:

Minimum: –5 dB, Maximum: +3 dB (23°C  $\pm$  5°C)

Minimum: –7 dB, Maximum: +5 dB (5 °C to 40 °C)

### Measurement accuracy (at 23 °C $\pm$ 5 °C)

Conditions <sup>1</sup>

The measurement accuracy is specified when the following conditions are met:

Calibration: open, short and load calibration is completed at the test port (7-mm connector) of the high temperature cable

Calibration temperature: calibration is performed at an environmental temperature within the range of 23 °C  $\pm$  5 °C. Measurement accuracy doubles when calibration temperature is +5 °C to +18 °C or +28 °C to +40 °C.

Measurement temperature range: Within  $\pm$  5 °C of calibration temperature

Measurement plane: Same as calibration plane

Impedance, admittance and phase angle accuracy:

$$|Z|, |Y| \pm \frac{(E_a + E_b)}{100} [\%]$$

(see Figure 31 through Figure 34 for calculated accuracy)

$$\theta \pm \frac{(E_a + E_b)}{100} [\text{rad}]$$

1. The high temperature cable must be kept at the same position throughout calibration and measurement.

## Option E4991B-007 Temperature Characteristic Test Kit (Continued)

where,

$$E_a = \begin{array}{l} \text{At } -23 \text{ dBm} \leq \text{oscillator level} \leq 1 \text{ dBm:} \\ 0.70 [\%] \text{ (1 MHz} \leq f \leq 100 \text{ MHz)} \\ 0.80 [\%] \text{ (100 MHz} < f \leq 500 \text{ MHz)} \\ 1.10 [\%] \text{ (500 MHz} < f \leq 1 \text{ GHz)} \\ 2.10 [\%] \text{ (1 GHz} < f \leq 1.8 \text{ GHz)} \\ 4.10 [\%] \text{ (1.8 GHz} < f \leq 3 \text{ GHz)} \end{array}$$

$$\begin{array}{l} \text{At } -33 \text{ dBm} \leq \text{oscillator level} < -23 \text{ dBm:} \\ 0.75 [\%] \text{ (1 MHz} \leq f \leq 100 \text{ MHz)} \\ 0.85 [\%] \text{ (100 MHz} < f \leq 500 \text{ MHz)} \\ 1.15 [\%] \text{ (500 MHz} < f \leq 1 \text{ GHz)} \\ 2.15 [\%] \text{ (1 GHz} < f \leq 1.8 \text{ GHz)} \\ 4.15 [\%] \text{ (1.8 GHz} < f \leq 3 \text{ GHz)} \end{array}$$

$$\begin{array}{l} \text{At } -40 \text{ dBm} \leq \text{oscillator level} < -33 \text{ dBm:} \\ 0.90 [\%] \text{ (1 MHz} \leq f \leq 100 \text{ MHz)} \\ 1.00 [\%] \text{ (100 MHz} < f \leq 500 \text{ MHz)} \\ 1.30 [\%] \text{ (500 MHz} < f \leq 1 \text{ GHz)} \\ 2.30 [\%] \text{ (1 GHz} < f \leq 1.8 \text{ GHz)} \\ 4.30 [\%] \text{ (1.8 GHz} < f \leq 3 \text{ GHz)} \\ \text{(Where, } f \text{ is frequency)} \end{array}$$

$$E_b = \left( \frac{Z_s}{|Z_x|} + Y_o \times |Z_x| \right) \times 100 [\%]$$

Where,

$$|Z_x| = \text{Measurement value of } |Z|$$

$$Z_s = \begin{array}{l} \text{At oscillator level} = -3 \text{ dBm, or } -13 \text{ dBm:} \\ (23 + 0.5 \times F) [\text{m}\Omega] \text{ (point averaging factor} \geq 8) \\ (24 + 0.5 \times F) [\text{m}\Omega] \text{ (point averaging factor} \leq 7) \end{array}$$

$$\begin{array}{l} \text{At oscillator level} = -23 \text{ dBm:} \\ (24 + 0.5 \times F) [\text{m}\Omega] \text{ (point averaging factor} \geq 8) \\ (28 + 0.5 \times F) [\text{m}\Omega] \text{ (point averaging factor} \leq 7) \end{array}$$

$$\begin{array}{l} \text{At } -23 \text{ dBm} < \text{oscillator level} \leq 1 \text{ dBm:} \\ (29 + 0.5 \times F) [\text{m}\Omega] \text{ (point averaging factor} \geq 8) \\ (36 + 0.5 \times F) [\text{m}\Omega] \text{ (point averaging factor} \leq 7) \end{array}$$

$$\begin{array}{l} \text{At } -33 \text{ dBm} \leq \text{oscillator level} < -23 \text{ dBm:} \\ (35 + 0.5 \times F) [\text{m}\Omega] \text{ (point averaging factor} \geq 8) \\ (70 + 0.5 \times F) [\text{m}\Omega] \text{ (point averaging factor} \leq 7) \end{array}$$

$$\begin{array}{l} \text{At } -40 \text{ dBm} \leq \text{oscillator level} < -33 \text{ dBm:} \\ (50 + 0.5 \times F) [\text{m}\Omega] \text{ (point averaging factor} \geq 8) \\ (150 + 0.5 \times F) [\text{m}\Omega] \text{ (point averaging factor} \leq 7) \end{array}$$

(Where,  $F$  is frequency in MHz)

$$Y_o = \begin{array}{l} \text{At } -17 \text{ dBm} \leq \text{oscillator level} \leq 1 \text{ dBm:} \\ (8 + 0.1 \times F) [\mu\text{S}] \text{ (averaging factor} \geq 8) \\ (10 + 0.1 \times F) [\mu\text{S}] \text{ (averaging factor} \leq 7) \end{array}$$



## Option E4991B-007 Temperature Characteristic Test Kit (Continued)

At  $-23 \text{ dBm} \leq \text{oscillator level} < -17 \text{ dBm}$ :  
 $(10 + 0.1 \times F) [\mu\text{S}]$  (averaging factor  $\geq 8$ )  
 $(14 + 0.1 \times F) [\mu\text{S}]$  (averaging factor  $\leq 7$ )

At  $-33 \text{ dBm} \leq \text{oscillator level} < -23 \text{ dBm}$ :  
 $(15 + 0.1 \times F) [\mu\text{S}]$  (averaging factor  $\geq 8$ )  
 $(40 + 0.1 \times F) [\mu\text{S}]$  (averaging factor  $\leq 7$ )

At  $-40 \text{ dBm} \leq \text{oscillator level} < -33 \text{ dBm}$ :  
 $(35 + 0.1 \times F) [\mu\text{S}]$  (averaging factor  $\geq 8$ )  
 $(80 + 0.1 \times F) [\mu\text{S}]$  (averaging factor  $\leq 7$ )

(Where, F is frequency in MHz)

## Calculated Impedance/Admittance Measurement Accuracy

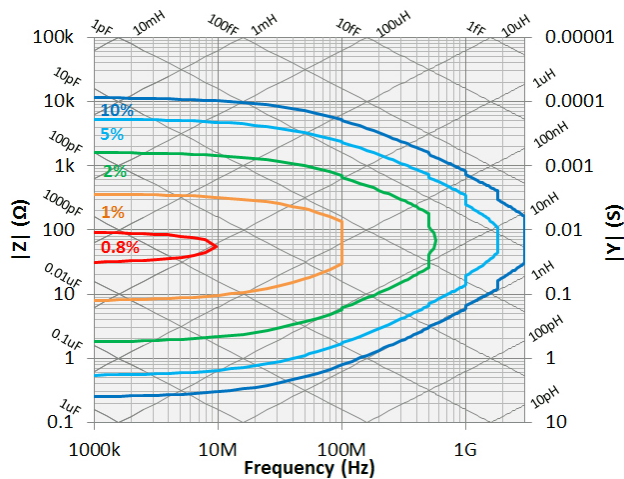

Figure 31.  $|Z|$ ,  $|Y|$  measurement accuracy when open/short/load calibration is performed. Oscillator level =  $-13 \text{ dBm}$ ,  $-3 \text{ dBm}$ . Point averaging factor  $\geq 8$  within  $\pm 5 \text{ }^\circ\text{C}$  of calibration temperature.

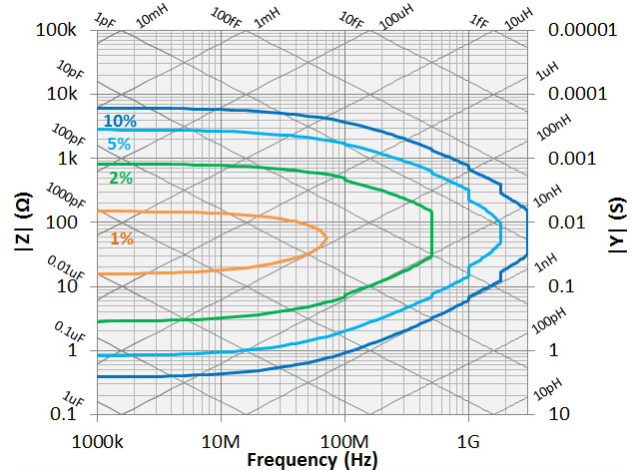

Figure 33.  $|Z|$ ,  $|Y|$  measurement accuracy when open/short/load calibration is performed. Oscillator level =  $-33 \text{ dBm}$ . Point averaging factor  $\geq 8$  within  $\pm 5 \text{ }^\circ\text{C}$  of calibration temperature.

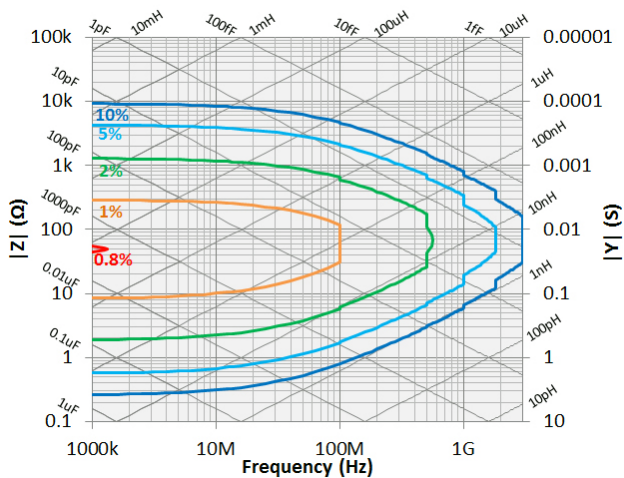

Figure 32.  $|Z|$ ,  $|Y|$  measurement accuracy when open/short/load calibration is performed. Oscillator level  $-13 \text{ dBm}$ ,  $-3 \text{ dBm}$ . Point averaging factor  $\leq 7$  within  $\pm 5 \text{ }^\circ\text{C}$  of calibration temperature.

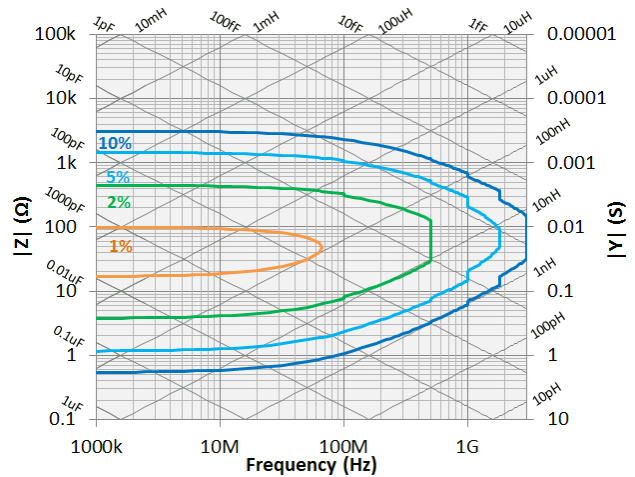

Figure 34.  $|Z|$ ,  $|Y|$  measurement accuracy when open/short/load calibration is performed. Oscillator level =  $-33 \text{ dBm}$ . Point averaging factor  $\leq 7$  within  $\pm 5 \text{ }^\circ\text{C}$  of calibration temperature.

# Typical Effects of Temperature Change on Measurement Accuracy

When the temperature at the test port (7-mm connector) of the high temperature cable changes from the calibration temperature, typical measurement accuracy involving temperature dependence effects (errors) is applied. The typical measurement accuracy is represented by the sum of error due to temperature coefficients ( $E'_a$ ,  $Y'_o$  and  $Z'_s$ ), hysteresis error ( $E_{ah}$ ,  $Y_{oh}$  and  $Z_{sh}$ ) and the specified accuracy.

## Conditions

Temperature compensation:

Temperature compensation data is acquired at the same temperature points as measurement temperatures.

Typical measurement accuracy (involving temperature dependence effects):

$$|Z|, |Y|: \pm (E_a + E_b + E_c + E_d) [\%]$$

$$\theta : \pm \frac{(E_a + E_b + E_c + E_d)}{100} [\text{rad}]$$

Where,  $E_a, E_b$  = Refer pages 25 and 26.

$$E_c = E'_a \times \Delta T + E_{ah} [\%]$$

$$E_d = \left[ \frac{Z'_s \times \Delta T + Z_{sh} + (Y'_o \times \Delta T + Y_{oh}) \times |Z_x|}{|Z_x|} \right] \times 100 [\%]$$

Where,

$|Z_x|$  = Measurement value of  $|Z|$

Here,  $E'_a, Z'_s$  and  $Y'_o$  are given by the following equations:

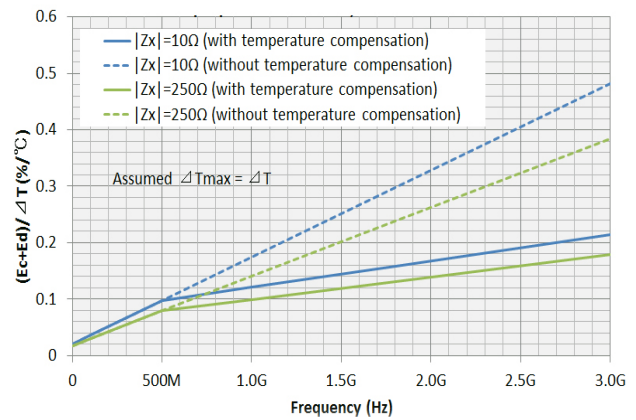

Figure 35. Typical frequency characteristics of temperature coefficient,  $(E_c+E_d)/\Delta T$ , when  $|Z_x| = 10 \Omega$  and  $250 \Omega$ .

	Without temperature compensation	With temperature compensation	
		1 MHz $\leq f <$ 500 MHz	500 MHz $\leq f \leq$ 3 GHz
$E'_a$	0.006 + 0.015 $\times f$ [%/°C]	0.006 + 0.015 $\times f$ [%/°C]	0.006 + 0.015 $\times f$ [%/°C]
$Z'_s$	1 + 10 $\times f$ [mΩ/°C]	1 + 10 $\times f$ [mΩ/°C]	5 + 2 $\times f$ [mΩ/°C]
$Y'_o$	0.3 + 3 $\times f$ [ $\mu$ S/°C]	0.3 + 3 $\times f$ [ $\mu$ S/°C]	1.5 + 0.6 $\times f$ [ $\mu$ S/°C]



## Typical Effects of Temperature Change on Measurement Accuracy (Continued)

$f$  = Measurement frequency in GHz

$E_{ah}$ ,  $Z_{sh}$  and  $Y_{oh}$  are given by following equations:

$$E_{ah} = E_a' \times \Delta T_{max} \times 0.3 \text{ [%]}$$

$$Z_{sh} = Z_s' \times \Delta T_{max} \times 0.3 \text{ [m}\Omega\text{]}$$

$$Y_{oh} = Y_o' \times \Delta T_{max} \times 0.3 \text{ [\mu S]}$$

$\Delta T$  = Difference of measurement temperature—from calibration temperature.  
Use  $\Delta T = 0$  °C if temperature compensation is set to off and the difference  $\leq 5$  °C.  
Use  $\Delta T = 0$  °C if temperature compensation is set to on and the difference  $\leq 20$  °C.

$\Delta T_{max}$  = Maximum temperature change (°C) at the test port from calibration temperature after the calibration is performed. Use  $\Delta T_{max} = 0$  °C if maximum temperature change  $\leq 10$  °C.

## Typical Material Measurement Accuracy When Using Options 002 and 007

Material measurement accuracy contains the permittivity and permeability measurement accuracy when the E4991B with Option 002 and 007 is used with the 16453A or 16454A test fixture.

### Measurement parameter

Permittivity parameters:  $|\epsilon_r|$ ,  $\epsilon_r'$ ,  $\epsilon_r''$ ,  $\tan\delta$

Permeability parameters:  $|\mu_r|$ ,  $\mu_r'$ ,  $\mu_r''$ ,  $\tan\delta$

### Frequency

Use with Keysight 16453A: 1 MHz to 1 GHz (typical)

Use with Keysight 16454A: 1 MHz to 1 GHz (typical)

### Operation temperature

Range:

- -55 °C to +150 °C (at the test port of the high temperature cable)
- +5 °C to +40 °C (Main unit, test head, and their connection cable)

### Typical material measurement accuracy (-55 °C to 150 °C)

Conditions

The measurement accuracy is specified when the following conditions are met:

Calibration:

- Open, short, and load calibration at electrodes of 16453A when using the 16453A
- Open, short, and load calibration at test port (7-mm connector) of the high temperature cable, then Short compensation at 16454A when using the 16454A. User frequency mode <sup>1</sup>

1. In fixed frequency calibration mode, if a measurement frequency point is not included in the calibration points, the accuracy at the measurement point is degraded to its doubled value (typical).

## Typical Material Measurement Accuracy When Using Options 002 and 007 (Continued)

Calibration temperature: Calibration is performed at an environmental temperature within the range of 23 °C ± 5 °C. Measurement accuracy doubles when calibration temperature is 5 °C to 18 °C or 28 °C to 40 °C. Measurement temperature range of main unit, test head, and their connecting cable.

- Within ± 5 °C of calibration temperature
- Oscillator level: Same as the level set at calibration
- Point averaging factor: ≥ 8

Typical permittivity measurement accuracy <sup>1</sup>:

$$\epsilon_r' \text{ accuracy} \quad \left( E_\epsilon = \frac{\Delta \epsilon_{r,m}'}{\epsilon_{r,m}'} \right):$$

$$\pm \left[ 5 + \left( 10 + \frac{0.5}{f} \right) \times \frac{t}{\epsilon_{r,m}'} + 0.25 \times \frac{\epsilon_{r,m}'}{t} + \frac{100}{\left| 1 - \left( \frac{13}{f \sqrt{\epsilon_{r,m}'}} \right)^2 \right|} \right]$$

[%] (at  $\tan \delta < 0.1$ )

Loss tangent accuracy of  $\epsilon_r'$  (=  $\Delta \tan \delta$ ) :

$$\pm (E_a + E_b) \text{ (at } \tan \delta < 0.1)$$

where,

$$E_a =$$

at Frequency ≤ 1 GHz

$$0.002 + \frac{0.0025}{f} \times \frac{t}{\epsilon_{r,m}'} + (0.008 \times f) + \frac{0.1}{\left| 1 - \left( \frac{13}{f \sqrt{\epsilon_{r,m}'}} \right)^2 \right|}$$

$$E_b = \left[ \frac{\Delta \epsilon_{r,m}'}{\epsilon_{r,m}'} \times \frac{1}{100} + \epsilon_{r,m}' \frac{0.002}{t} \right] \times \tan \delta$$

$f$  = Measurement frequency [GHz]

$t$  = Thickness of MUT (material under test) [mm]

$\epsilon_{r,m}'$  = Measured value of  $\epsilon_r'$

$\tan \delta$  = Measured value of dielectric loss tangent

1. The accuracy applies when the electrode pressure of the 16453A is set to maximum.

## Typical Material Measurement Accuracy When Using Options 002 and 007 (Continued)

Typical permeability measurement accuracy:

$$\mu_r' \text{ accuracy} \quad E_\mu = \frac{\Delta\mu_{r,m}'}{\mu_{r,m}'} :$$

$$4 + \frac{0.02}{f} \times \frac{25}{F \times \mu_{r,m}'} + F \times \mu_{r,m}' \times \left[ 1 + \frac{15}{F \times \mu_{r,m}'} \right]^2 \times f^2$$

[%] (at  $\tan\delta < 0.1$ )

Loss tangent accuracy of  $\mu_r$  ( $= \Delta\tan\delta$ ) :

$$\pm (E_a + E_b) \text{ (at } \tan\delta < 0.1)$$

where,

$$E_a = 0.002 + \frac{0.005}{F \times \mu_{r,m}' \times f} + 0.004 \times f$$

$$E_b = \frac{\Delta\mu_{r,m}'}{\mu_{r,m}'} \times \frac{\tan\delta}{100}$$

$$f = \text{Measurement frequency [GHz]}$$

$$F = h \ln \frac{c}{b} \text{ [mm]}$$

$$h = \text{Height of MUT (material under test) [mm]}$$

$$b = \text{Inner diameter of MUT [mm]}$$

$$c = \text{Outer diameter of MUT [mm]}$$

$$\mu_{r,m}' = \text{Measured value of } \mu_r'$$

$$\tan\delta = \text{Measured value of loss tangent}$$

# Examples of Calculated Permittivity Measurement Accuracy

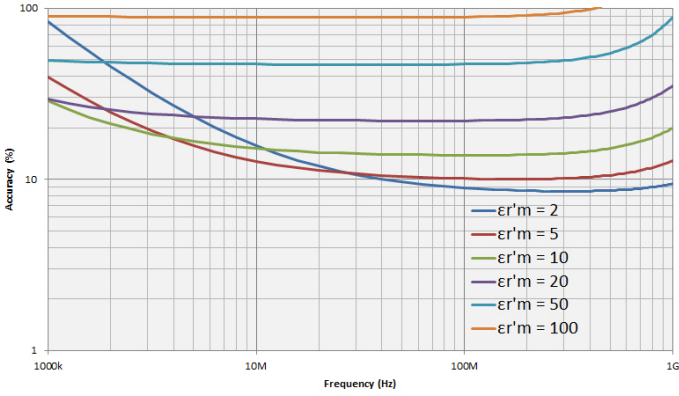

Figure 36. Permittivity accuracy ( $\frac{\Delta \epsilon'_r}{\epsilon'_r}$ ) vs. frequency, (at  $t = 0.3$  mm typical)

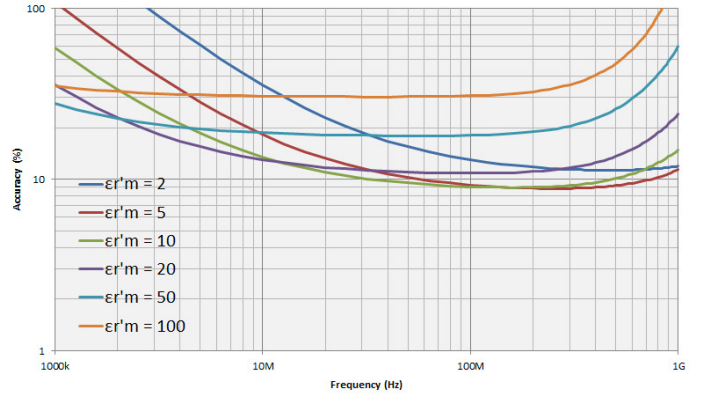

Figure 39. Dielectric loss tangent ( $\tan \delta$ ) accuracy vs. frequency (at  $t = 0.3$  mm, typical) <sup>1</sup>

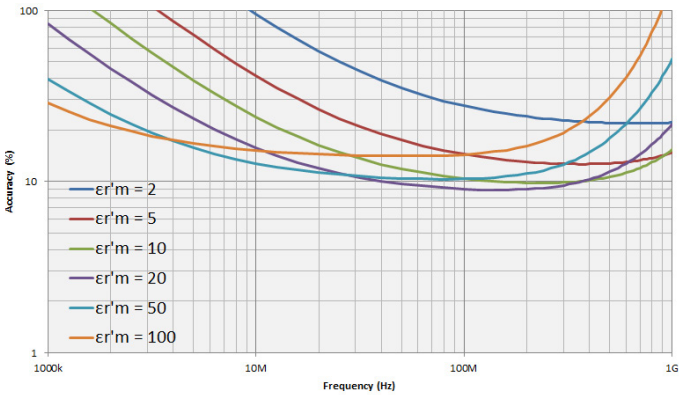

Figure 37. Permittivity accuracy ( $\frac{\Delta \epsilon'_r}{\epsilon'_r}$ ) vs. frequency, (at  $t = 1$  mm typical)

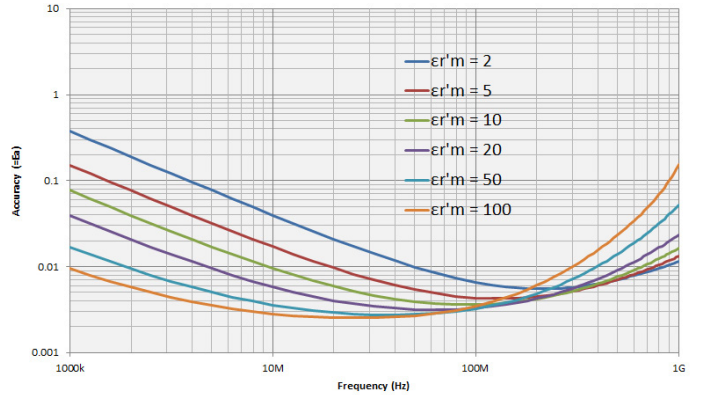

Figure 40. Dielectric loss tangent ( $\tan \delta$ ) accuracy vs. frequency (at  $t = 1$  mm, typical) <sup>1</sup>

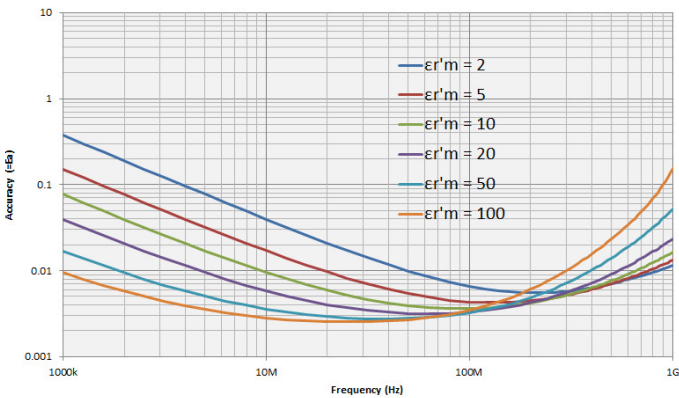

Figure 38. Permittivity accuracy ( $\frac{\Delta \epsilon'_r}{\epsilon'_r}$ ) vs. frequency, (at  $t = 3$  mm typical)

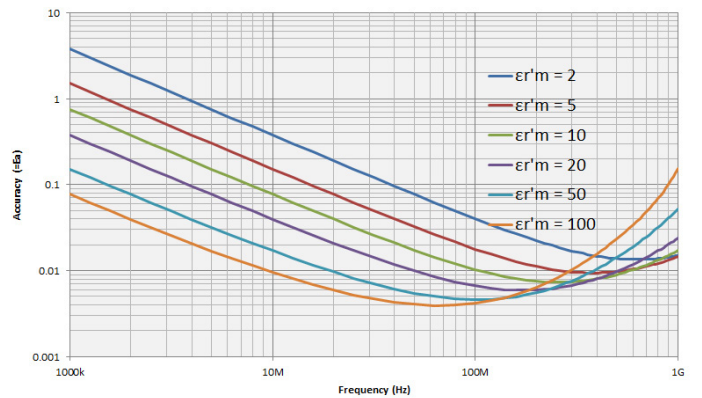

Figure 41. Dielectric loss tangent ( $\tan \delta$ ) accuracy vs. frequency (at  $t = 3$  mm, typical) <sup>1</sup>

1. The typical accuracy of  $\tan \delta$  is defined as  $E_a + E_b$ ; refer to "Typical permittivity measurement accuracy" on page 28.

## Examples of Calculated Permittivity Measurement Accuracy (Continued)

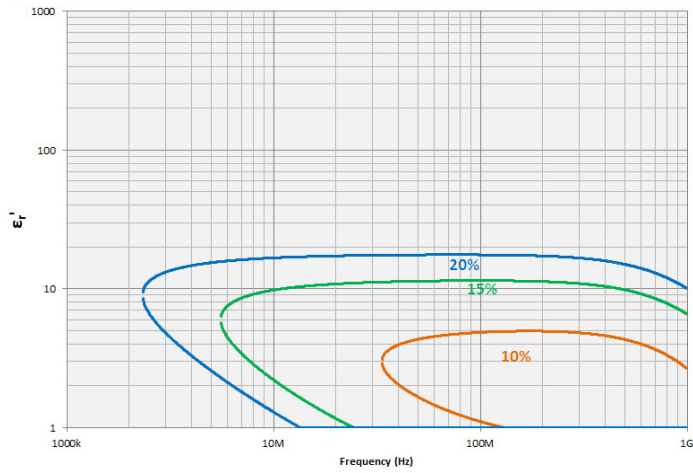

Figure 42. Permittivity ( $\epsilon_r$ ) vs. frequency (at  $t = 0.3$  mm, typical)

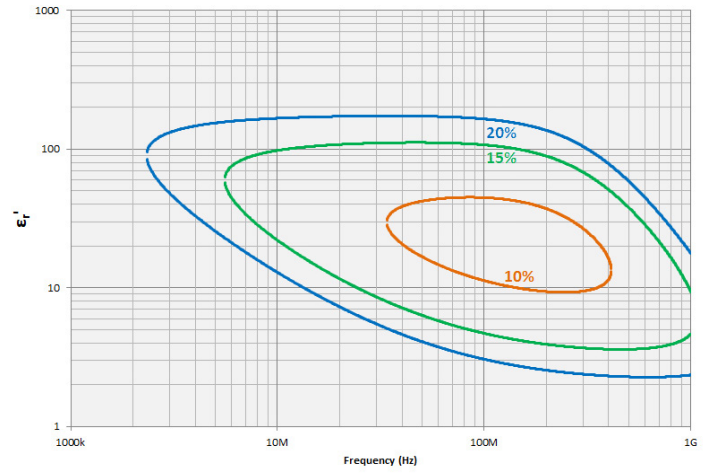

Figure 44. Permittivity ( $\epsilon_r$ ) vs. frequency (at  $t = 3$  mm, typical)

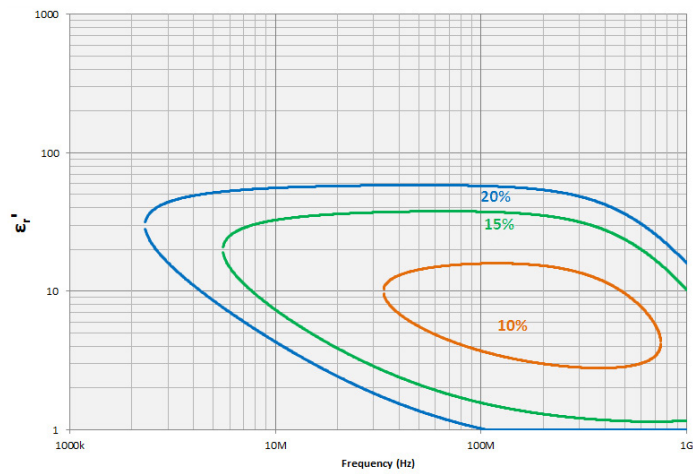

Figure 43. Permittivity ( $\epsilon_r$ ) vs. frequency (at  $t = 1$  mm, typical)

# Examples of Calculated Permittivity Measurement Accuracy (continued)

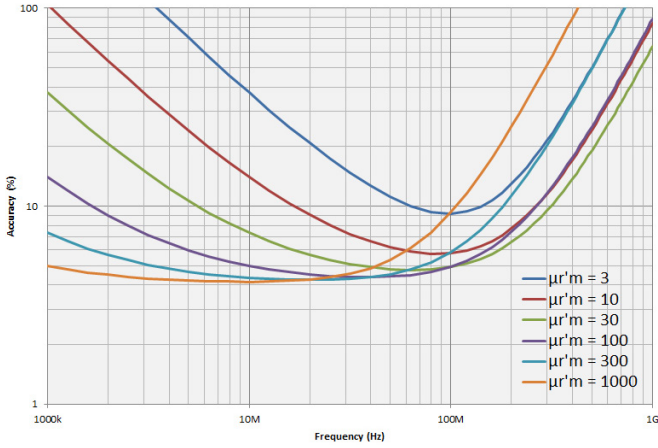

Figure 45. Permeability accuracy ( $\frac{\Delta\mu_r}{\mu_r}$ ) vs. frequency (at  $F = 0.5$  mm, typical)

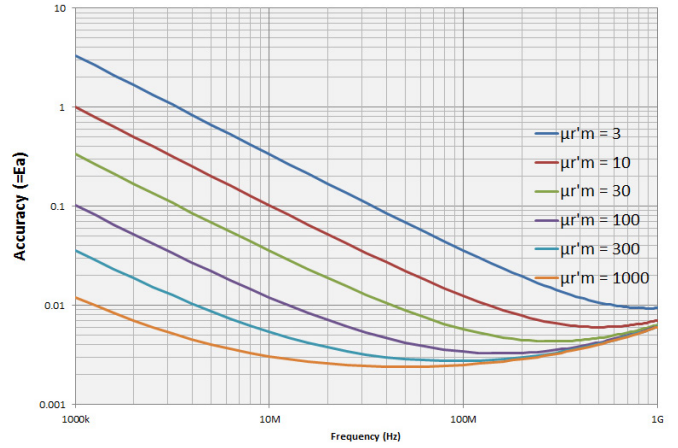

Figure 48. Permeability loss tangent ( $\tan\delta$ ) accuracy vs. frequency (at  $F = 0.5$  mm, typical)<sup>1</sup>

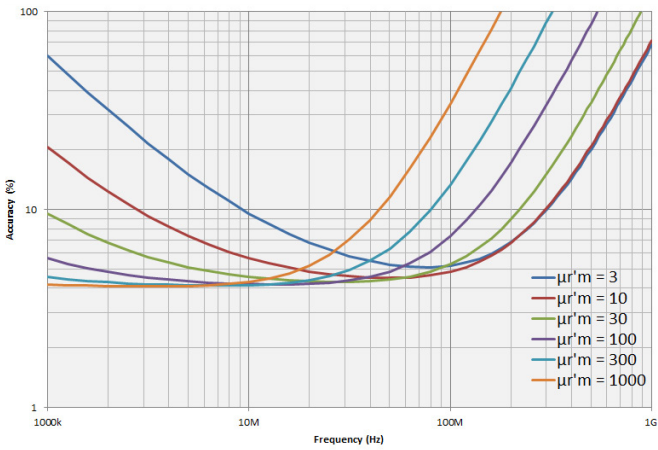

Figure 46. Permeability accuracy ( $\frac{\Delta\mu_r}{\mu_r}$ ) vs. frequency (at  $F = 3$  mm, typical)

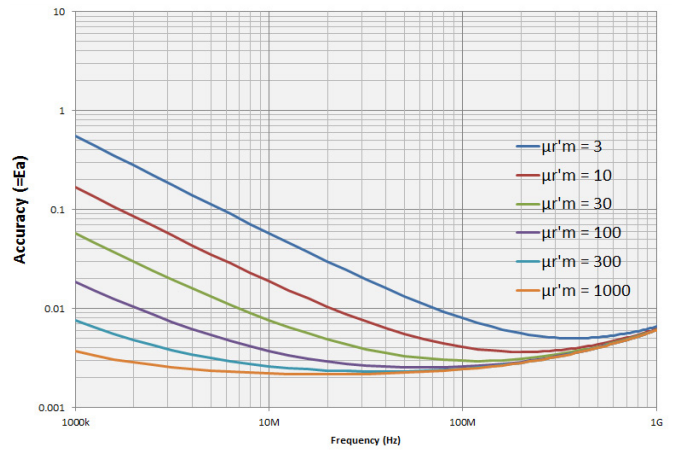

Figure 49. Permeability loss tangent ( $\tan\delta$ ) accuracy vs. frequency (at  $F = 3$  mm, typical)<sup>1</sup>

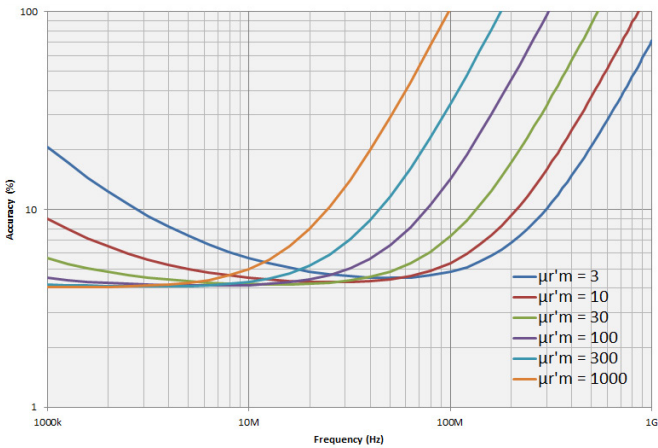

Figure 47. Permeability accuracy ( $\frac{\Delta\mu_r}{\mu_r}$ ) vs. frequency (at  $F = 10$  mm, typical)

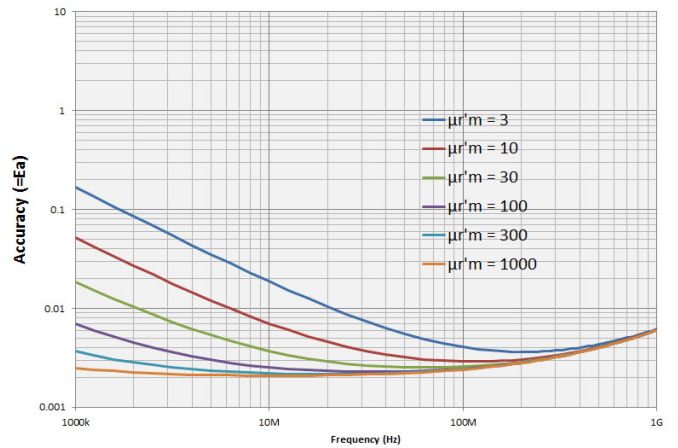

Figure 50. Permeability loss tangent ( $\tan\delta$ ) accuracy vs. Frequency (at  $F = 10$  mm, typical)<sup>1</sup>

1. This graph shows only frequency dependence of  $E_a$  for simplification. The typical accuracy of  $\tan\delta$  is defined as  $E_a + E_b$ ; refer to "Typical permeability measurement accuracy" on page 28.

# Examples of Calculated Permeability Measurement Accuracy (continued)

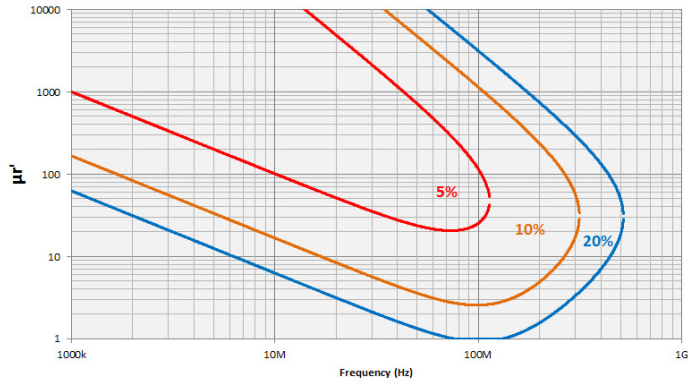

Figure 51. Permeability ( $\mu'$ ) vs. frequency (at  $F = 0.5$  mm, typical)

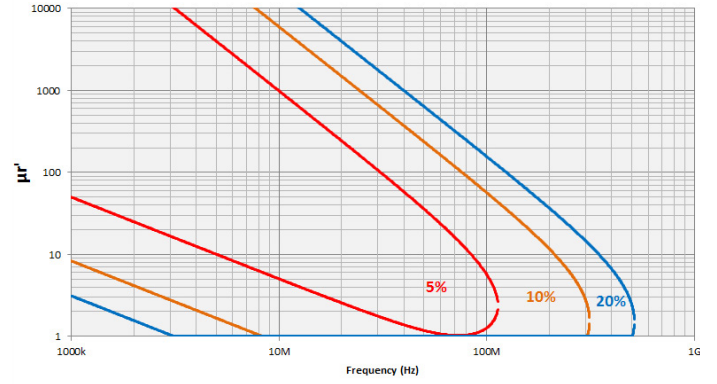

Figure 53. Permeability ( $\mu'$ ) vs. frequency (at  $F = 10$  mm, typical)

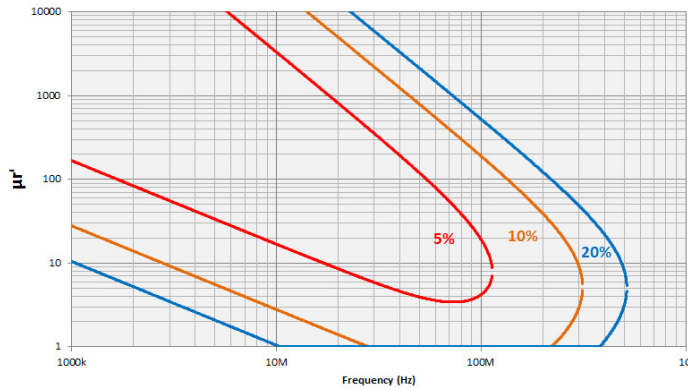

Figure 52. Permeability ( $\mu'$ ) vs. frequency (at  $F = 3$  mm, typical)

# Typical Effects of Temperature Change on Permittivity Measurement Accuracy

When the temperature at the test port (7-mm connector) of the high temperature cable changes more than 5 °C from the calibration temperature, the typical permittivity measurement accuracy involving temperature dependence effects (errors) is applied. The typical permittivity accuracy is represented by the sum of error due to temperature coefficient ( $T_c$ ), hysteresis error ( $T_c \times \Delta T_{max}$ ) and the accuracy at 23 °C  $\pm$  5 °C.

Typical accuracy of permittivity parameters:

$$\epsilon'_r \text{ accuracy } \left( = \frac{\Delta \epsilon'_{r,m}}{\epsilon'_{r,m}} \right):$$

$$\pm (E_\epsilon + E_f + E_g) [\%]$$

Loss tangent accuracy of  $\epsilon'' (= \Delta \tan \delta)$  :

$$\pm \frac{(E_\epsilon + E_f + E_g)}{100}$$

where,

$E_\epsilon$  = Permittivity measurement accuracy at 23 °C  $\pm$  5 °C

$$E_f = T_c \times \Delta T \times 100$$

$$E_g = T_c \times \Delta T_{max} \times 0.3 \times 100$$

$$T_c [\text{°C}^{-1}] = K_1 + K_2 + K_3$$

See Figure 54 through Figure 56 for the calculated value of  $T_c$

without temperature compensation

$$K_1 [\text{°C}^{-1}] = 1 \times 10^{-6} \times (60 + 150 \times f)$$

$$K_2 [\text{°C}^{-1}] =$$

$$3 \times 10^{-6} \times (1 + 10 \times f) \times \left( \frac{\epsilon'_{r,m}}{t} \times \frac{1}{\left| 1 - \left( \frac{f}{f_0} \right)^2 \right|} + 10 \right) \times f$$

$$K_3 [\text{°C}^{-1}] =$$

$$5 \times 10^{-3} \times (0.3 + 3 \times f) \times \left( \frac{\epsilon'_{r,m}}{t} \times \frac{1}{\left| 1 - \left( \frac{f}{f_0} \right)^2 \right|} + 10 \right) \times f$$



## Typical Effects of Temperature Change on Permittivity Measurement Accuracy (Continued)

Typical accuracy of permittivity parameters (Continued):  
with temperature compensation

$$K_1 = 1 \times 10^{-6} \times (60 + 150 \times f)$$

$$K_2 = \text{at } 1 \text{ MHz} \leq f < 500 \text{ MHz}$$

$$3 \times 10^{-6} \times (1 + 10 \times f) \times \left( \frac{\epsilon'_{r,m}}{t} \times \left| \frac{1}{1 - \left(\frac{f}{f_0}\right)^2} \right| + 10 \right) \times f$$

at 500 MHz  $\leq f \leq$  1 GHz

$$3 \times 10^{-6} \times (5 + 2 \times f) \times \left( \frac{\epsilon'_{r,m}}{t} \times \left| \frac{1}{1 - \left(\frac{f}{f_0}\right)^2} \right| + 10 \right) \times f$$

$$K_3 = \text{at } 1 \text{ MHz} \leq f < 500 \text{ MHz}$$

$$5 \times 10^{-3} \times (0.3 + 3 \times f) \times \frac{1}{\left( \frac{\epsilon'_{r,m}}{t} \times \left| \frac{1}{1 - \left(\frac{f}{f_0}\right)^2} \right| + 10 \right) \times f}$$

at 500 MHz  $\leq f \leq$  1 GHz

$$5 \times 10^{-3} \times (1.5 + 0.6 \times f) \times \frac{1}{\left( \frac{\epsilon'_{r,m}}{t} \times \left| \frac{1}{1 - \left(\frac{f}{f_0}\right)^2} \right| + 10 \right) \times f}$$

$f$  = Measurement frequency [GHz]

$$f_0 = \frac{13}{\sqrt{\epsilon'_{r,m}}} \text{ [GHz]}$$

$t$  = Thickness of MUT (material under test) [mm]

$\epsilon'_{r,m}$  = Measured value of  $\epsilon'_r$

$\Delta T$  = Difference of measurement temperature from calibration temperature  
Use  $\Delta T = 0$  °C if temperature compensation is set to off and the difference  $\leq 5$  °C.  
Use  $\Delta T = 0$  °C if temperature compensation is set to on and the difference  $\leq 20$  °C.

$\Delta T_{max}$  = Maximum temperature change (°C) at test port from calibration temperature after the calibration is performed.  
Use  $\Delta T_{max} = 0$  °C if maximum temperature change  $\leq 10$  °C.

# Typical Effects of Temperature Change on Permittivity Measurement Accuracy (Continued)

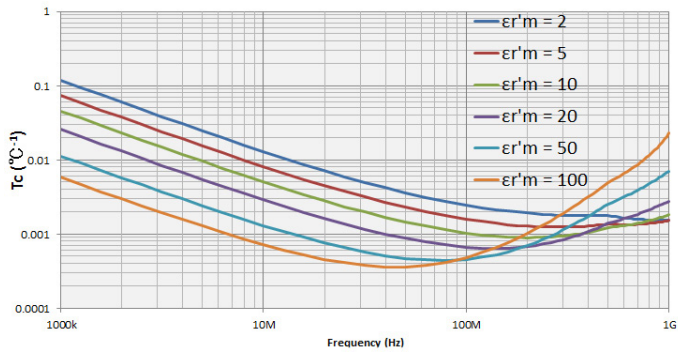

Figure 54. Typical frequency characteristics of temperature coefficient of  $\epsilon'_r$  (Thickness = 0.3 mm)

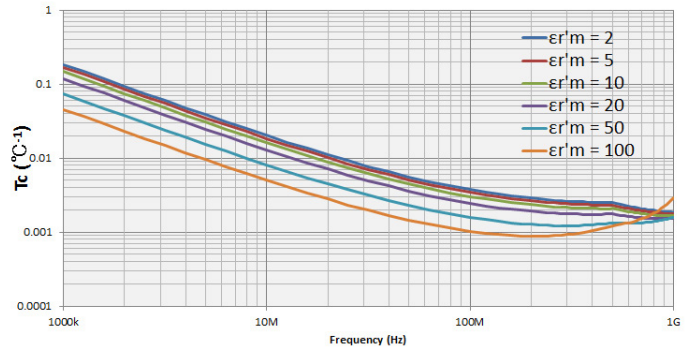

Figure 56. Typical frequency characteristics of temperature coefficient of  $\epsilon'_r$  (Thickness = 3 mm)

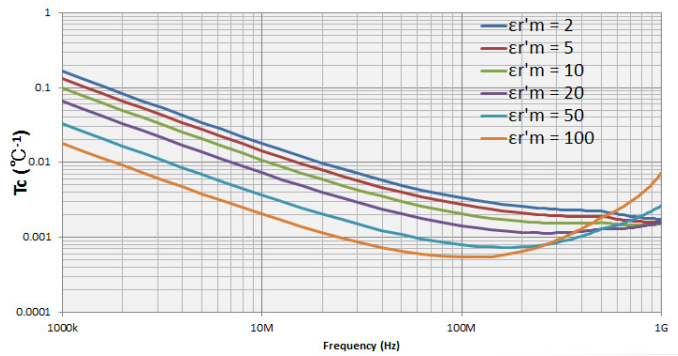

Figure 55. Typical frequency characteristics of temperature coefficient of  $\epsilon'_r$  (Thickness = 1 mm)

## Typical Effects of Temperature Change on Permeability Measurement Accuracy

When the temperature at the test port (7-mm connector) of the high temperature cable changes more than 5 °C from the calibration temperature, the typical permeability measurement accuracy involving temperature dependence effects (errors) is applied. The typical permeability accuracy is represented by the sum of error due to temperature coefficient ( $T_c$ ), hysteresis error ( $T_c \times \Delta T_{max}$ ) and the accuracy at 23 °C  $\pm$  5 °C.

Typical accuracy of permeability parameters:

$$\mu_r' \text{ accuracy } \left( = \frac{\Delta \mu_r'}{\mu_r'} \right):$$

$$\pm (E_\mu + E_h + E_i) [\%]$$

Loss tangent accuracy of  $\mu_r$  (=  $\Delta \tan \delta$ ):

$$\pm \frac{(E_\mu + E_h + E_i)}{100}$$

where,

$$E_\mu = \text{Permeability measurement accuracy at } 23 \text{ }^\circ\text{C} \pm 5 \text{ }^\circ\text{C}$$

$$E_h = T_c \times \Delta T \times 100$$

$$E_i = T_c \times \Delta T_{max} \times 0.3 \times 100$$

$$T_c [^\circ\text{C}^{-1}] = K_4 + K_5 + K_6$$

See Figure 57 through Figure 59 for the calculated value of  $T_c$  without temperature compensation

$$K_4 [^\circ\text{C}^{-1}] = 1 \times 10^{-6} \times (60 + 150 \times f)$$

$$K_5 [^\circ\text{C}^{-1}] =$$

$$1 \times 10^{-2} \times (1 + 10 \times f) \times \frac{|1 - 0.01 \times \{F \times (\mu_r' - 1) + 10\} \times f^2|}{\{F \times (\mu_r' - 1) + 20\} \times f}$$

$$K_6 [^\circ\text{C}^{-1}] =$$

$$2 \times 10^{-6} \times (0.3 + 3 \times f) \times \frac{\{F \times (\mu_r' - 1) + 20\} \times f}{|1 - 0.01 \times \{F \times (\mu_r' - 1) + 10\} \times f^2|}$$

with temperature compensation

$$K_4 = 1 \times 10^{-6} \times (60 + 150 \times f)$$

$$K_5 =$$

At 1 MHz  $\leq f <$  500 MHz

$$1 \times 10^{-2} \times (1 + 10 \times f) \times \frac{|1 - 0.01 \times \{F \times (\mu_r' - 1) + 10\} \times f^2|}{\{F \times (\mu_r' - 1) + 20\} \times f}$$

At 500 MHz  $\leq f \leq$  1 GHz

$$1 \times 10^{-2} \times (5 + 2 \times f) \times \frac{|1 - 0.01 \times \{F \times (\mu_r' - 1) + 10\} \times f^2|}{\{F \times (\mu_r' - 1) + 20\} \times f}$$

## Typical Effects of Temperature Change on Permeability Measurement Accuracy (Continued)

Typical accuracy of permeability parameters (Continued):

$$K_6 = \text{at } 1 \text{ MHz} \leq f < 500 \text{ MHz}$$
$$2 \times 10^{-6} \times (0.3 + 3 \times f) \times \frac{\{F \times (\mu'_m - 1) + 20\} \times f}{|1 - 0.01 \times \{F \times (\mu'_m - 1) + 10\} \times f^2|}$$

at 500 MHz  $\leq f \leq$  1 GHz

$$2 \times 10^{-6} \times (1.5 + 0.6 \times f) \times \frac{\{F \times (\mu'_m - 1) + 20\} \times f}{|1 - 0.01 \times \{F \times (\mu'_m - 1) + 10\} \times f^2|}$$

$f$  = Measurement frequency [GHz]

$F$  =  $h \ln \frac{c}{b}$  [mm]

$h$  = Height of MUT (material under test) [mm]

$b$  = Inner diameter of MUT [mm]

$c$  = Outer diameter of MUT [mm]

$\mu'_{rm}$  = Measured value of  $\mu'_r$

$\Delta T$  = Difference of measurement temperature from calibration temperature.  
Use  $\Delta T = 0$  °C if temperature compensation is set to off and the difference  $\leq 5$  °C.  
Use  $\Delta T = 0$  °C if temperature compensation is set to on and the difference  $\leq 20$  °C.

$\Delta T_{max}$  = Maximum temperature change (°C) at test port from calibration temperature after the calibration is performed.  
Use  $\Delta T_{max} = 0$  °C if maximum temperature change  $\leq 10$  °C.

# Typical Effects of Temperature Change on Permeability Measurement Accuracy (Continued)

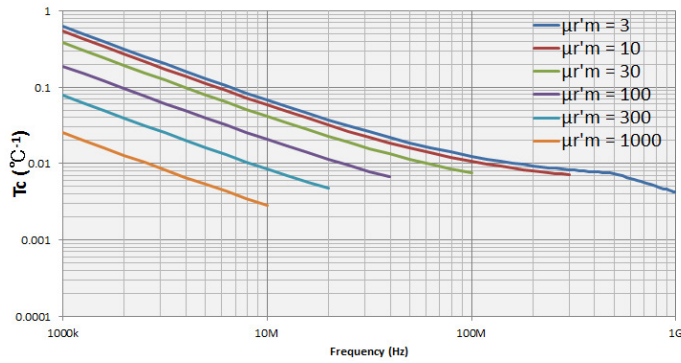

Figure 57. Typical frequency characteristics of temperature coefficient of  $\mu_r'$  (at  $F = 0.5$  mm)

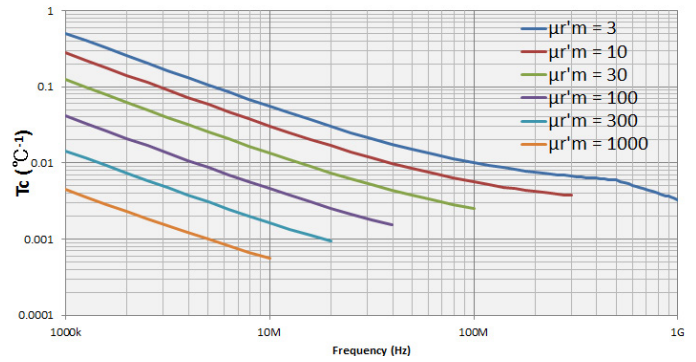

Figure 58. Typical frequency characteristics of temperature coefficient of  $\mu_r'$  (at  $F = 3$  mm)

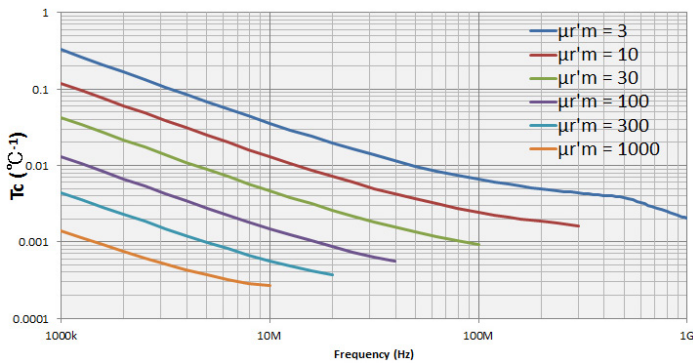

Figure 59. Typical frequency characteristics of temperature coefficient of  $\mu_r'$  (at  $F = 10$  mm)

Learn more at: [www.keysight.com](http://www.keysight.com)

For more information on Keysight Technologies' products, applications or services, please contact your local Keysight office. The complete list is available at: [www.keysight.com/find/contactus](http://www.keysight.com/find/contactus)

