

Product

Battery Simulation Test Solution
BSS 2000/ BSS 2000Pro

BSS 2000

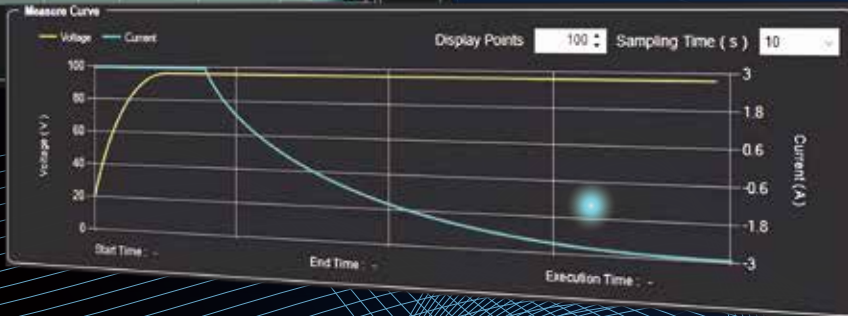
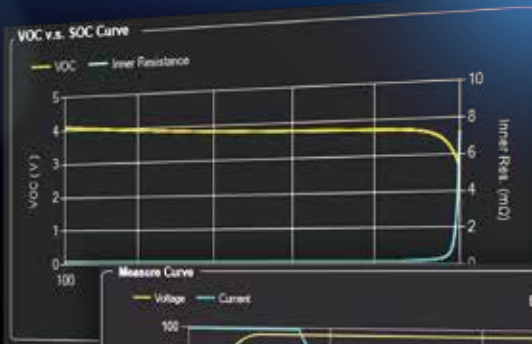

Battery Simulation Test Solution

BSS 2000/ BSS 2000Pro

APPLICATIONS

- EV
- Solar Industry

Your Power Testing Solution

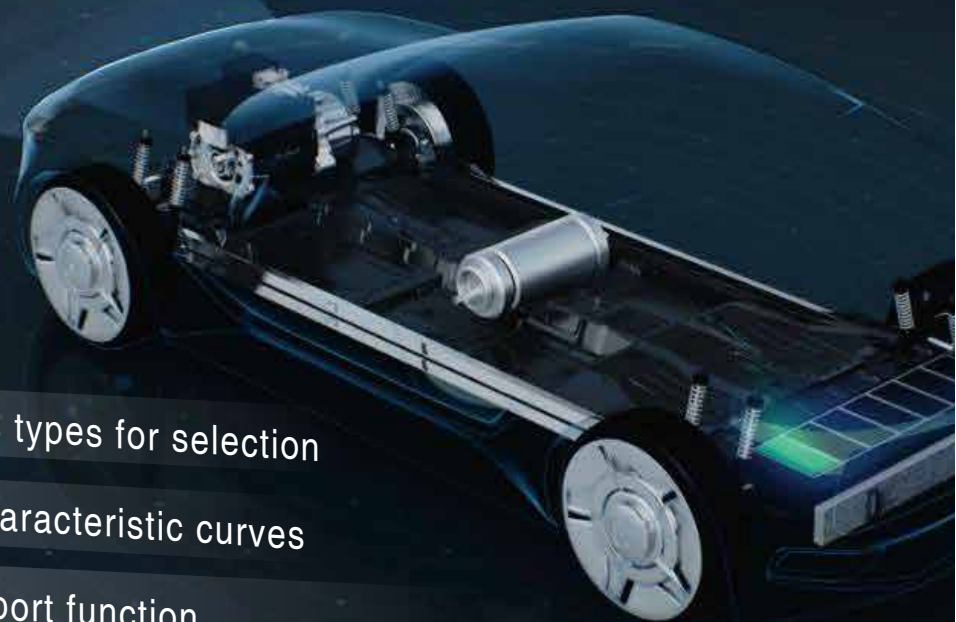
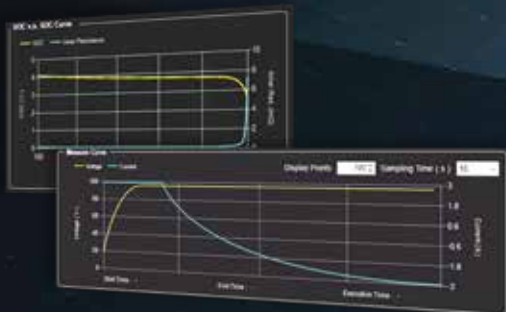

Built-in abundant batteries types for selection

User-defined battery characteristic curves

Support .mat file import function

With the development of battery technology, battery weight and energy density are further improved while the cost is reducing, making batteries widely used in new energy vehicles, photovoltaic energy storage and consumer electronics products. In order to fully verify the performance of the product in different SOC states of the battery, engineers need to conduct lots of tests in the early stage of R&D to continuously optimize the product design or select a more suitable battery.

The BSS2000 basic version and BSS2000 Pro version of the battery simulating software are products specifically designed for the above test scenarios. On the one hand, it will solve the problem of increasing cost of buying and storage of different types of batteries; On the other hand, the battery simulator can be quickly set to different state of SoC without real charge and discharge process, greatly improve test efficiency. The advanced version of BSS2000 Pro is developed to meet higher level testing requests. Based on the basic version of BSS2000, Matlab, BMS protocol customization and more built-in battery types are provided with the Pro version software. BSS2000 & BSS2000 Pro software combined with ITECH's latest high-performance bidirectional DC power supply, IT6000B/IT6000C/IT-M3400/IT-M3600, covering a power range up to 1152kW, can provide users with a wide range simulation solution covering low-power battery module to high-power power battery system simulation.

FEATURE

- Battery simulation range: 2250V / 1152kW
- Support multi-channel battery module status simulation
- Bidirectional regenerative battery simulator, regenerative efficiency up to 95%
- Seamless switching between battery charging and discharging mode
- Support user-defined battery characteristic curve import
- Support quick set up of battery characteristic curves by input common parameters
- Support .mat file import function
- BMS protocol self-defined function, realize CAN bus communication with the external control unit ^{*1}
- Built-in various battery types (include LAB,Li-on,LMO, LNMCO, LNMCO&LMO,LFP,LTO and NiMH .) ^{*2}
- Battery protection parameter setting function
- Battery output initial state of charge setting function
- Ideal data report function
- Battery curve preview and real-time curve display function
- Flexible expansion by parallel for larger current/power simulation request

*1 BSS2000 Pro

*2 BSS2000 basic version software is used to simulate lead-acid and lithium-ion batteries.

Your Power Testing Solution

BSS2000 Battery Simulation Software

Applications

E-mobility

EV Powertrain testing, DC Charger testing
FCEV PDU power distribution unit testing

Solar PV

Renewable energy storage control unit
test, smart micro grid PCS testing

Others

Aerospace and defense energy storage
battery simulation test and more

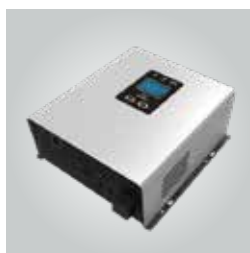

Common battery parameters setting and function simulation

By combined various types of battery modelling and high-speed algorithms, BSS2000 Basic & BSS2000 Pro Battery Simulation Software provide the user with real-time battery curve simulation function. No need to know the specific internal characteristics of the battery, the user only needs to select the battery type and the battery characteristic curve can be generated easily by setting a few basic parameters, parameters including full voltage, empty voltage, rated capacity, serial qty, parallel qty and battery internal resistance, etc. Thanks to the strong support of ITECH hardware, the battery simulator can simulate up to 1152kW battery packs, covering the test requests of solar PV ,energy storage, EV and other high-power fields.

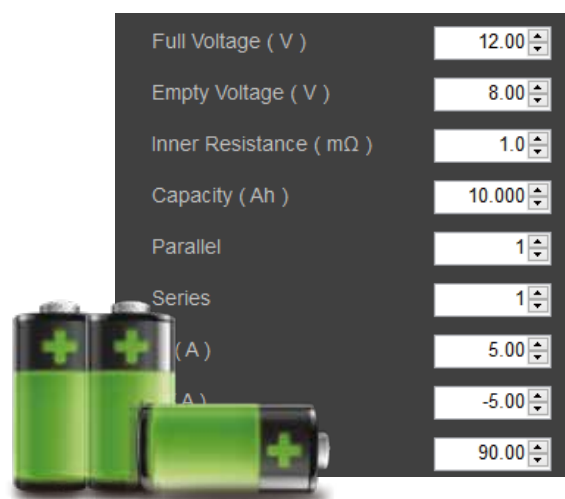

User-defined battery characteristic curve

BSS2000 / BSS2000 Pro Battery Simulation Software provides the battery curve simulation function by Importing Data in ARB to meet the needs of various simulation requests. Users can import the measured battery charge and discharge data in a csv file to simulate the battery charge and discharge characteristic curve. This function is not only suitable for the simulation of conventional batteries, but also for the simulation of some special batteries or novel batteries.

SOC	OCV	R
0	2.654	7.25179
0.1	2.689676	6.28948
0.2	2.724133	5.463998
0.3	2.757411	4.755715
0.4	2.789552	4.147823
0.5	2.820595	3.625931
0.6	2.850577	3.177712
0.7	2.879535	2.792612
0.8	2.907504	2.461595

Your Power Testing Solution

BSS2000 Battery Simulation Software

Support .mat file import function

BSS2000 Pro

BSS2000 Pro battery simulator provides professional battery researchers with the function of importing .mat files, through which users can simulate the corresponding battery characteristic curves under different battery mathematical models. This function is of great significance for the research on the adaptability of new batteries and products, and the application of conventional batteries in special environments. Conventional types of battery characteristic curves or mathematical models are generally based on typical conditions, and for new batteries or applications in special environments, engineers often need to construct new battery mathematical models to more realistically reflect the performance of batteries in specific application contexts. This function is specially developed for such applications. Users can build a new battery mathematical model through a third-party MATLAB * simulation platform and import it into BSS2000 Pro for simulation, and then verify the battery's adaptability in practical applications.

* MATLAB is a mathematical software developed by MathWorks, USA

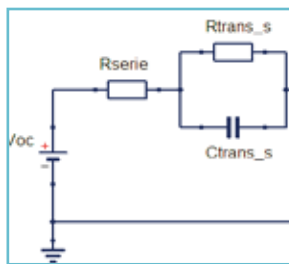

Matlab Simulink platform

Support .mat file import function

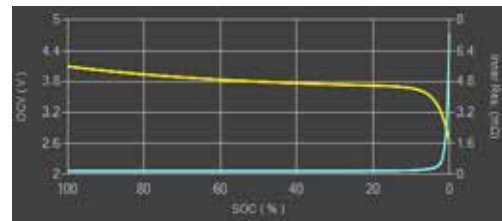

BSS2000 Software

Built-in various batteries types for selection

BSS2000 Pro

BSS2000 Pro Battery Simulation Software provides users with unique Modelling functions, by built-in commonly used battery types and characteristics into the software. The user only needs to select the battery type and configure the series and parallel parameters to simulate the characteristic curves of battery modules of different types and different capacities. The battery types selectable by BSS2000 Pro include Lion, LMO, LNMCO, LNMCO&LMO, LFP, LTO and NiMH.

* BSS2000 basic version software is used to simulate lead-acid and lithium-ion batteries.

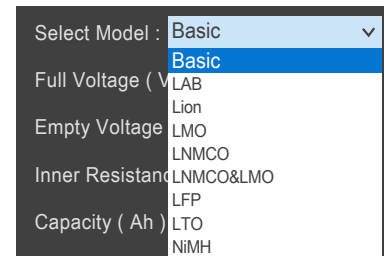

BMS protocol self-defined function

BSS2000 Pro

The BSS2000 Pro Battery Simulation Software can not only simulate the battery pack, but also provide the simulation function of the battery management system (BMS). The user can self-define the BMS protocol to match the application of different scenarios and realize the CAN communication with the external control unit. In the process of simulating the entire power battery system (battery pack + BMS), BSS2000 Pro can regularly report major parameters such as the actual voltage, current, and remaining capacity of the battery simulator, so that accordingly the external DUT can quickly respond to different states of the battery simulator in real-time.

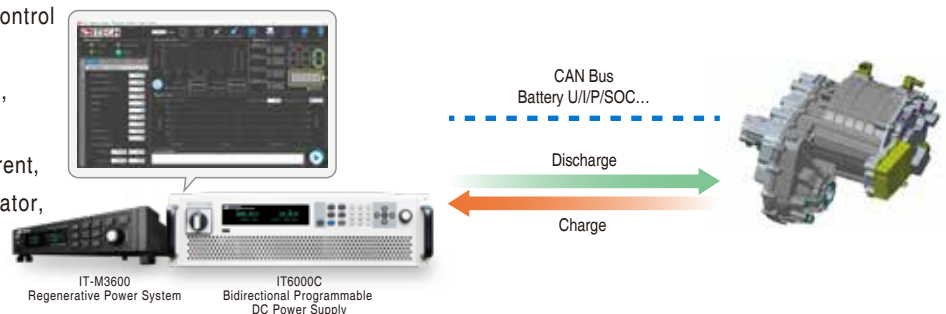

Initial capacity setting function

The BSS2000/BSS2000 Pro battery simulator allows the user to set the initial capacity of the battery to study the startup characteristics or energy management characteristics of DUT when the battery is fully charged or depleted, without the need to perform real charging and discharging, and improve test efficiency.

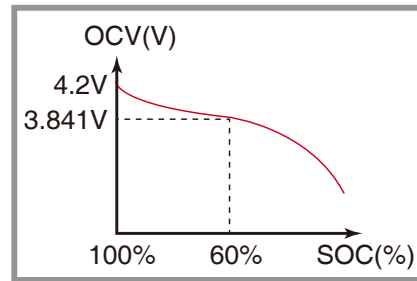

Real-time parameter monitoring

The BSS2000/BSS2000 Pro battery simulator provides multi-channel control function and supports preview function of edited curves. Meanwhile, during the test operation, the operating parameters and operating curves of the battery simulator are monitored in real time. In order to facilitate research and test personnel to trace the experimental data, the software provides report generation function, and the saved data includes voltage, current, power, SoC, charge/ discharge status, and capacity.

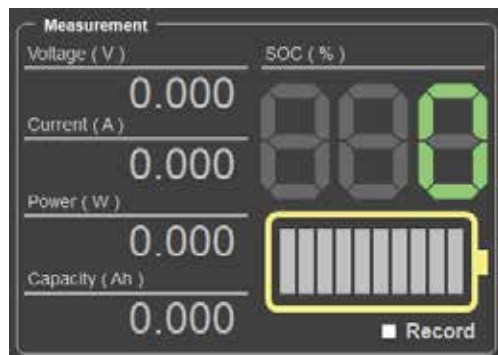

Seamless battery charge / discharge simulation

In real life scenarios, such as the EV field, as the vehicle decelerates, accelerates, or brakes, the battery continuously switches between the two states of discharge and energy recovery. Therefore, the battery simulator also needs to flexibly switch between being charged and discharge status and respond in a timely manner according to external state changes. The BSS2000/BSS2000 Pro battery simulator benefits from the hardware advantages of source and load in one device, which can realize the seamless switching between charging and discharging, to simulate the characteristics of the battery more realistically.

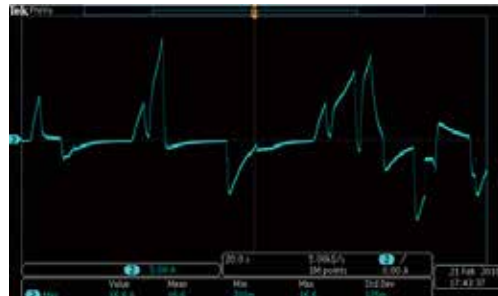

Battery simulator protection parameter settings

In practical applications, in order to extend the service life of the battery and prevent the battery from overcharge and overdischarge, the BMS (battery management system) in the battery pack will limit the safety range of the battery for different applications. When it is higher or lower than the protection limit value, the software cut down the circuit in time to protect the battery and DUT. BSS2000/BSS2000 Pro battery simulator supports multiple protection condition settings: SoC upper/lower alarm value setting, SoC upper/lower protection value setting; OCV upper/lower alarm value setting, OCV upper/lower protection value setting.

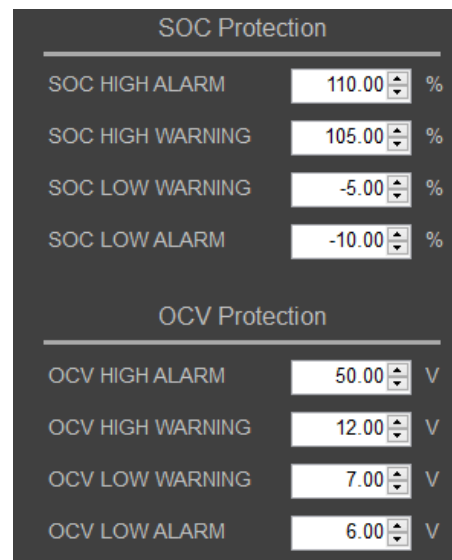

Your Power Testing Solution

BSS2000 Battery Simulation Software

Battery simulator

Application field 1 -Hydrogen fuel cell vehicle

Test purpose -verify the energy management strategies of fuel cells and lithium-ion battery packs

Mode 1 Power battery and fuel cell systems to power the motor

Mode 2 The fuel cell system powers the motor and charges the power battery at the same time (when the battery SOC is low)

Mode 3 Motor braking energy is feedback to power battery

ITECH solution -BSS2000 Pro battery simulator

Advantage

- battery simulator can simulate power battery + BMS, custom BMS protocol
- battery simulator can realize seamless switching between charging and discharging
- multiple built-in battery types (lithium battery, lithium iron phosphate battery...)

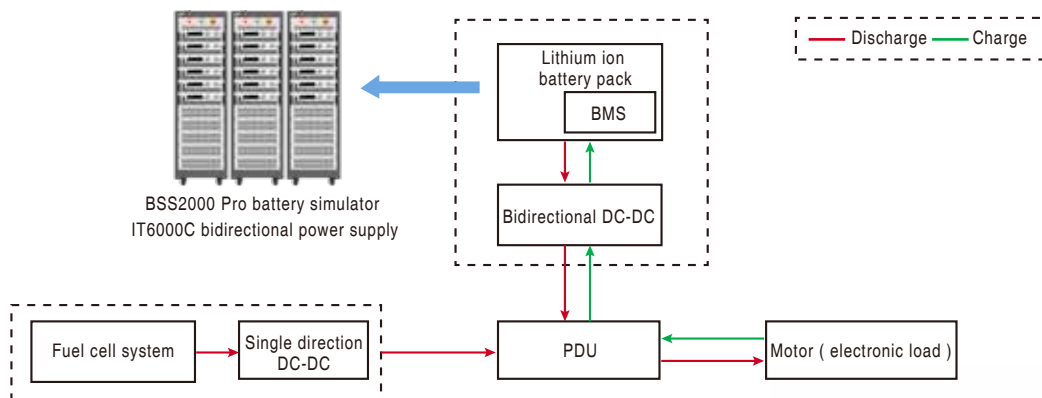
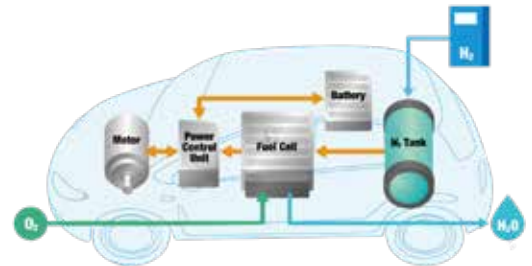

Application field 2 – MCU test

Test purpose -verify the MCU performance under different SOC

ITECH solution -BSS2000 Pro battery simulator

Advantage

- arbitrarily specify the initial SOC state of the battery
- verifies the performance of the MCU under the limit state of the battery power
- automatically absorb the reverse EMF of the motor to protect the MCU



BSS2000 battery simulator
IT6000C bidirectional power supply



Your Power Testing Solution

BSS2000 Battery Simulation Software

Application field 3 – Smart grid

Test purpose -Verify the PCS electrical performance of energy storage converter

ITECH solution -BSS2000 Pro battery simulator

Advantage -max. power of battery simulator is up to 1152kW
 -support multiple choices of battery types, including lithium battery, lead-acid battery, etc.

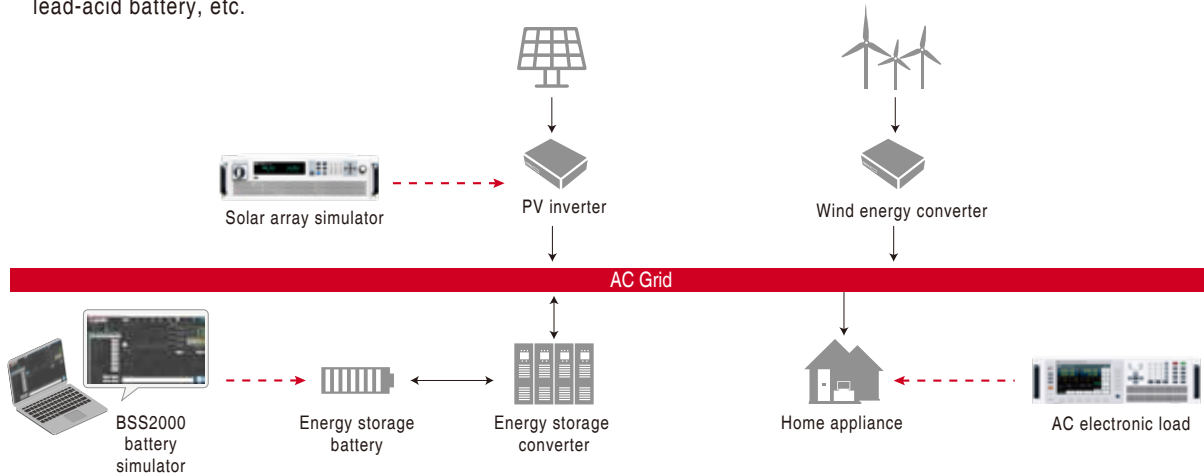

Application field 4- transportation

Test purpose -Research on Energy Distribution of Hydrogen Energy Tram Power System

ITECH solution -BSS2000 Pro battery simulator

Advantage -user-defined battery characteristic curve
 -supports the import of .mat format files, which is convenient for the performance research of the new kind of battery in the propulsion system
 -real-time display of current battery voltage, current, capacity, energy and SOC

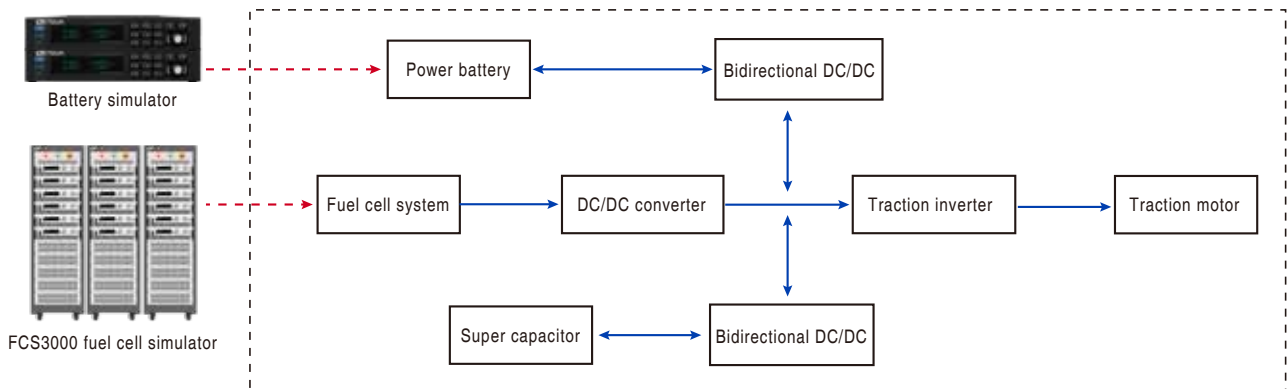

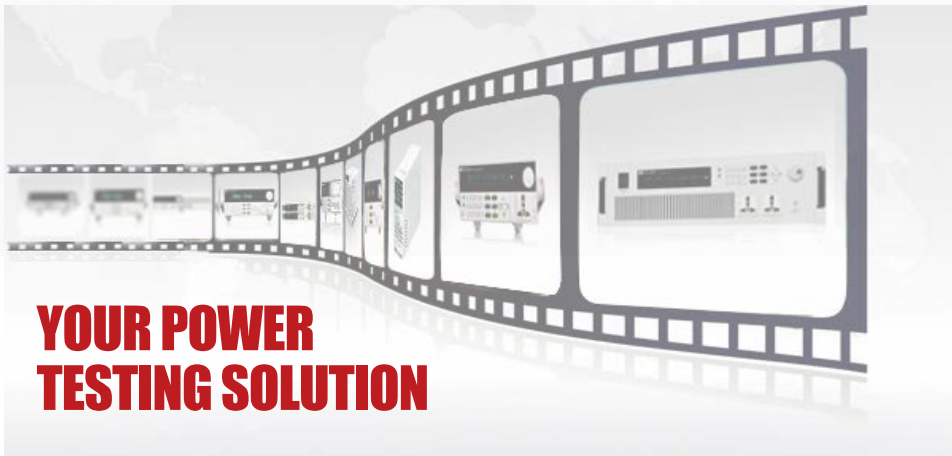
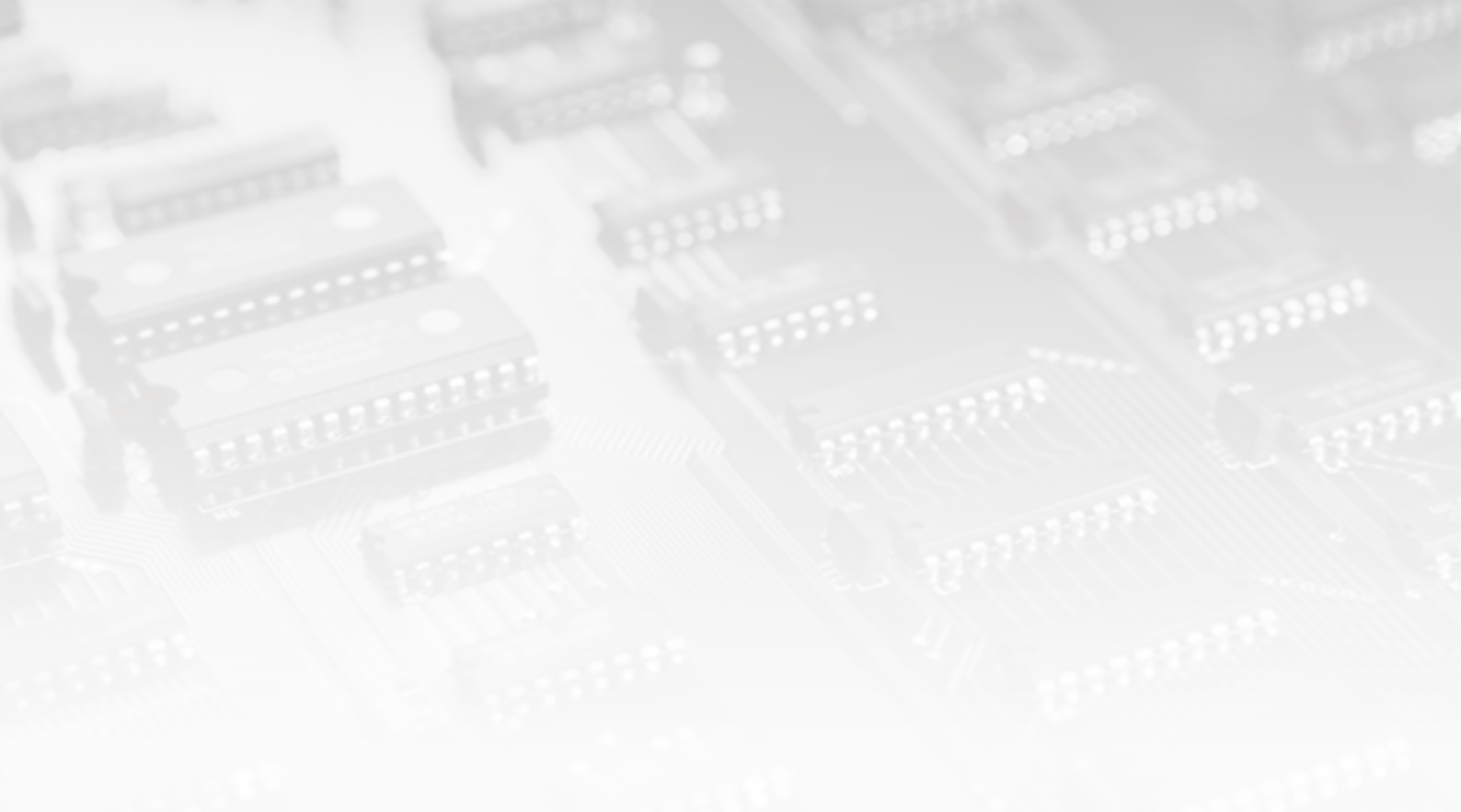

This information is subject to change without notice. For more information, please contact ITECH.

Taipei

Add: No.918, Zhongzheng Rd., Zhonghe Dist., New Taipei City
235, Taiwan

Web: www.itechate.com

TEL: +886-3-6684333

E-mail: info@itechate.com

Factory I

Add: No.108, XiShanqiao Nanlu, Nanjing city, 210039, China

TEL: +86-25-52415098

Web: www.itechate.com

Factory II

Add: No.150, Yaonanlu, Meishan Cun, Nanjing city, 210039, China

TEL: +86-25-52415099

Web: www.itechate.com



ITECH Web



ITECH Facebook